

Wireless World

JULY 1955

VOL. 61 No. 7

New Ideas in Electro-Acoustics

IN spite of the fact that the B.B.C.'s new v.h.f. service so far covers only a small part of the country, it seems the transmissions have stimulated a very wide interest in the whole field of sound reproduction—especially high-quality reproduction. As the report printed elsewhere in this issue on new electro-acoustic products at recent exhibitions will show, the industry has gone a long way to meet the growing demand that has arisen.

For sheer technical novelty, the new linear electrostatic loudspeakers are undoubtedly the high-lights among the recent introductions. If development proceeds along expected lines the loudspeaker, from being the weakest link in the chain, may become the component that sets the pace for the rest. But, although the electrostatic speaker has captured so much interest a great deal of steady work has been done during the past year on moving-coil types, and some highly developed versions have appeared.

Tape recording is slowly gaining ground at the expense of the disc. In tape equipment the demand for automatic operation seems to be growing, and both beginner and expert will probably welcome devices such as those which allow the selection of either track without changing over the spools. It is a fact that many people's enjoyment of a record is lessened if complicated manual processes are needed for working the reproducing equipment. Unfortunately, extreme simplicity in operation can only be attained at the cost of greater mechanical and electrical complexity. Obviously a happy balance has to be struck between conflicting factors, and present-day gear will meet most reasonable needs.

V.H.F. tuners or adaptors may at the present stage of development be legitimately regarded as electro-acoustic gear. Just as the user of a record reproducer objects to "fiddling" manual operations, so the listener to high-quality broadcasting objects to making constant adjustments of tuning. Frequency drift is quite a serious problem in all f.m. receiver design and its effects seem to go up in annoyance value in proportion to the quality of the associated amplifier and loudspeaker. Very few tuners appear to be entirely free of blame in this

respect and there is a pressing need for a cheap and effective solution of the problem of drift. Crystal frequency control has not yet, so far as we know, been used in commercially produced domestic gear, but it may yet be offered to those who are not satisfied with anything short of the best.

Legalized Recording

ALTHOUGH the programme of the new Parliament does not contain any proposals of direct radio interest, one legislative measure foreshadowed in the Queen's Speech may prove to be of considerable significance. It was stated that legislation will be introduced to reform the law of copyright; the reforms will be on the basis of recommendations made in 1952 in the Report of the Copyright Committee. The present Act, dating back to 1911, is obviously out of date, at any rate in relation to such comparatively recent developments as broadcasting and sound recording.

No doubt the proposed new Act will include the gist of a Bill which came before the last Parliament aiming at creating a special "right," called the television exhibiting right, in transmissions by the B.B.C. and I.T.A.

As our readers know, there has been some controversy over the legal position of those who make records of broadcast transmissions in their own homes. It is generally believed that, so long as there is no element of public performance in the playing-back of the record, no infringement of copyright is committed. However, confirmation would be welcome.

On this question of recording "off the air," most of our readers will, we imagine, endorse the views expressed recently by Norman Leever, president of the British Sound Recording Association. Mr. Leever, speaking at the B.S.R.A. annual dinner, said the reasonable interests of home recordists must be watched. The Association, while respecting the rights of copyright holders, artists and others, would oppose legislation aimed at preventing recording and playback of material within the home recordist's domestic circle.

Impedance and Admittance

Reactance and Resistance in Series and Parallel on the Slide Rule

By FRANCIS OAKES, M.Inst.E., A.M.Brit.I.R.E. and E. W. LAWSON, A.M.I.E.E.

CALCULATION of the more complex formulae encountered in the gentle art of electronics is a matter which involves us in lengthy labour, in the purchase of a book of nomograms, or in the memorizing of tricks enabling us to do it quickly by conventional moves on the slide rule. There is, however, yet another way of looking at the problem, namely, that of realizing that the fundamental operations of multiplication and division on the slide rule can be carried out in more than one fashion, and that by logical application of this elementary principle, considerable saving in time, and even improved accuracy, can be achieved—all without additional expense of money or of memory. In the following paragraphs, the com-

bination of reactance and resistance in series or parallel connection are used as examples to illustrate this.

Looking at the slide rule set for the multiplication $2 \times 3 = 6$, we have in front of us also a means for carrying out the division $\frac{6}{2} = 3$. It looks a little unfamiliar

at first, but it will soon be quite natural for us to make use of the fact that the dividend and the divisor on the stock coincide with the quotient and the end-mark, respectively, on the slide—and, of course, vice versa!

Armed with this knowledge (so obvious, once it is realized, that even a tired memory is not taxed by

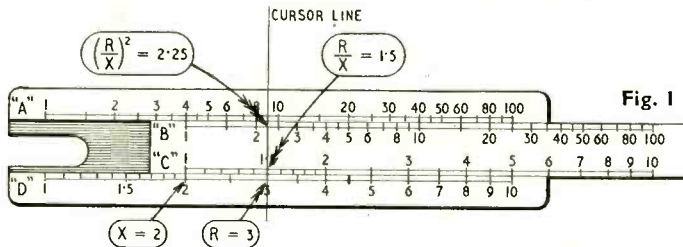

PARALLEL COMBINATION

Set "C" 1 (or 10) over "D" X. (Fig. 1, one arrow.)

Set cursor over "D" R. (Fig. 1, two arrows.)

Note cursor reading on "B" (Fig. 1, four arrows) and add 1.

Move slide to bring ("B" + 1) under cursor. (Fig. 2, one arrow.)

Read impedance under "C" 1 (or 10). (Fig. 2, three arrows.)

Read admittance above "D" 1 (or 10). (Fig. 2, four arrows.)

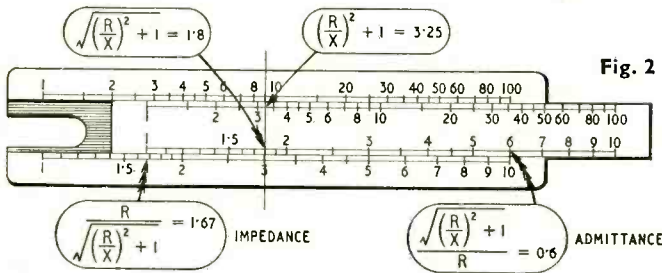

SERIES COMBINATION

Set "C" 1 (or 10) over "D" X. (Fig. 1, one arrow.)

Set cursor over "D" R. (Fig. 1, two arrows.)

Note cursor reading on "B" (Fig. 1, four arrows) and add 1.

Move cursor over ("B" + 1). (Fig. 3 one arrow.)

Read impedance on "D" under cursor, (Fig. 3, three arrows) or move slide to bring "C" 1 (or 10) under cursor. (Fig. 4, one arrow.)

Read admittance above "D" 1 (or 10). (Fig. 4, two arrows.)

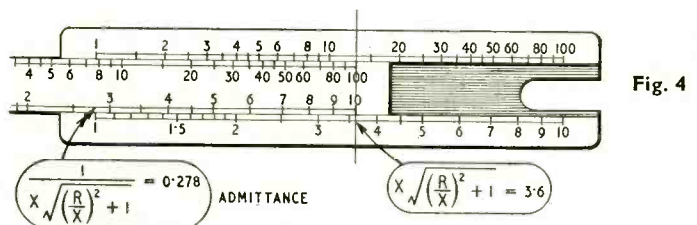
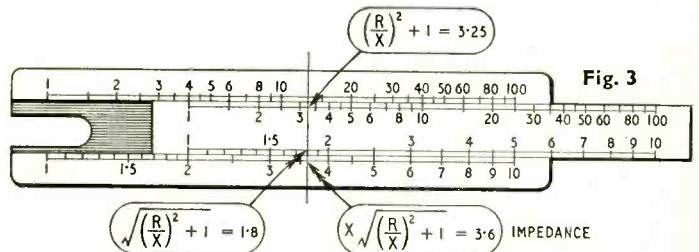

Calculations

having to remember anything) and, further armed with the old trick of writing

$$|Z| = \frac{R X}{\sqrt{R^2 + X^2}} \quad \text{as} \quad |Z| = \frac{R}{\sqrt{\left(\frac{R}{X}\right)^2 + 1}}$$

we can, for instance, find the impedance of a resistance of value R in parallel with a reactance of value X by the following simple operations:

(1) Set the end-mark of scale "C" over X on scale "D," (Fig. 1, one arrow), and the cursor over R on scale "D," (Fig. 1, two arrows); the quotient, $\frac{R}{X}$, appears under the cursor line on scale "C" (Fig. 1, three arrows). It need not be read off; instead, $\left(\frac{R}{X}\right)^2$ is found under the cursor line on scale "B" (Fig. 1, four arrows), then, mentally (with due care for its decimal value) one is added.

(2) The slide is now moved to bring $\left(\frac{R}{X}\right)^2 + 1$, instead of $\left(\frac{R}{X}\right)^2$, under the cursor line (Fig. 2, one arrow). This, of course, also brings $\sqrt{\left(\frac{R}{X}\right)^2 + 1}$

(instead of the old quotient, $\frac{R}{X}$), on scale "C" under the cursor line (Fig. 2, two arrows). The original dividend R is still in place, thus (by the customary method of division), the end-mark already points to the quotient, our required impedance, on scale "D" of the stock. (Fig. 2, three arrows). There, without further work or worry (or feats of memory) it is ready for reading off, or, possibly more important, it is in the correct position for continuing with subsequent calculations.

The impedance of a resistance of value R in series with a reactance of value X is given by $|Z| = \sqrt{R^2 + X^2}$,

which can be converted to $|Z| = X \sqrt{\left(\frac{R}{X}\right)^2 + 1}$. A start is made as before.

(1) Set the end-mark of the slide to X on scale "D" (Fig. 1, one arrow) and bring the cursor over R on scale "D" (Fig. 1, two arrows). Again, $\left(\frac{R}{X}\right)^2$ is read off (Fig. 1, four arrows). But this time;

(2) Instead of moving the slide, the cursor is moved to $\left(\frac{R}{X}\right)^2 + 1$ on the "B" scale (Fig. 3, one arrow).

No further moves are required, for the slide end-mark is still in place over X on the stock (Fig. 3, two

arrows), the cursor is now in place over $\sqrt{\left(\frac{R}{X}\right)^2 + 1}$

on the slide (Fig. 3, three arrows), thus, $X \sqrt{\left(\frac{R}{X}\right)^2 + 1}$, the required product, appears automatically under the hair-line (Fig. 3, four arrows)—again on the stock and ready for further use if required.

Incidentally, some may hold that this method is a slightly more elegant alternative for solving the root of the sum of two squares—described in the February issue of this journal—requiring less resetting of the rule.

As admittance is the reciprocal of the impedance (absolute values, of course), this is an easy matter to deal with. For the parallel combination, the admittance can be read off directly from the "C" scale above the end-mark of the stock (Fig. 2, four arrows), whilst for the series combination it simply means moving the end-mark of the slide under the cursor line (Fig. 4, one arrow), and reading the result on the slide, above the end-mark of the stock (Fig. 4, two arrows). Why?—simply because if $xy=1$, then

$$y = \frac{1}{x}$$

And there are still no tedious rules to be remembered—but for those who like afterthoughts it may be of interest to note that the series combination—to wit, the root of the sum of the squares—can be carried out by the same method, only with slide and stock exchanging their roles. The resulting impedance then appears on the slide and proud owners of a reciprocal scale can find the admittance thereupon—saving the extra move of the slide (with some slight reduction in consequent wear and tear).

PLASTICS

Some of the more interesting Radio Applications Seen at the Plastics Exhibition

THE good adhesion to metal inserts by Epikote potting resin was demonstrated by Shell Chemicals at the Plastics Exhibition held at Olympia by *British Plastics*. A neon tube encapsulated in Epikote "828" had had its glass envelope broken by external squeezing yet the neon continued to function as shown by the glow discharge when employed as a low-frequency oscillator.

Epikote "828" is a pale amber-coloured liquid which on the addition of a curing agent solidifies at ordinary room temperatures. It is thus a useful potting agent for radio parts. Its good high-frequency qualities were exemplified by a 250-Mc/s oscillator totally enclosed in Epikote "828." Scott Bader were showing Marco potting resins which also solidify without either heat or pressure.

The Telegraph Construction and Maintenance Company demonstrated the ease with which metal parts can be coated with Telcothene using the special powder they have produced for the purpose. It is available in various colours and the procedure is to apply the powder to the pre-heated article and then to "cook" for about five minutes in an oven at about 160° C. The coating has a high-gloss finish and possesses all the insulating properties of factory-produced Telcothene.

High-impact polystyrene, which is less brittle than the ordinary material, is being used now for radio cabinets and Ekco were showing examples produced by their plastics division. These cabinets have a smooth glossy surface, are tough, flexible and very resistant to impact.

It would seem that about 35 Mc/s is the optimum frequency for welding thin plastic sheet and fabrics; Redifon use this frequency in their "Rediweld" series of electronic heaters, while 36 Mc/s is favoured for the "Radyne" series made by Radio Heaters of Wokingham.

BOOKS RECEIVED

Precision Electrical Measurements. Proceedings of a symposium held at the National Physical Laboratory in November, 1954, covering capacitance and dielectrics, inductance and magnetics, electrotechnics, high-voltage measurements and impulse testing techniques. Pp. 345; Figs. 147. Price £1 7s 6d. Her Majesty's Stationery Office, York House, Kingsway, London, W.C.2.

The Physics of the Ionosphere. Collection of papers presented at a conference under the auspices of the Physical Society at the Cavendish Laboratory, September, 1954. Pp. 406; Figs. 167. Price 40s. The Physical Society, 1, Lowther Gardens, Prince Consort Road, London, S.W.7.

Defects in Crystalline Solids. Report of the conference held at Bristol in July, 1954, including papers on semi-conductors. Pp. 429; Figs. 324. Price 40s. The Physical Society, 1, Lowther Gardens, Prince Consort Road, London, S.W.7.

Calibration of Temperature Measuring Instruments. Description of methods employed at the National Physical Laboratory, covering electrical and non-electrical instruments. Pp. 47; Figs. 27. Price 2s. Her Majesty's Stationery Office, York House, Kingsway, London, W.C.2.

Radio Research 1954. Report of the Radio Research Board on the work of the year, which included the application of back-scatter technique to propagation research, investigations of semi-conductors and ferromagnetic materials. Pp. 47; Figs. 8. Price 2s 6d. Her Majesty's Stationery Office, York House, Kingsway, London, W.C.2.

AIRCRAFT SUB-MINIATURE DIRECTION FINDER

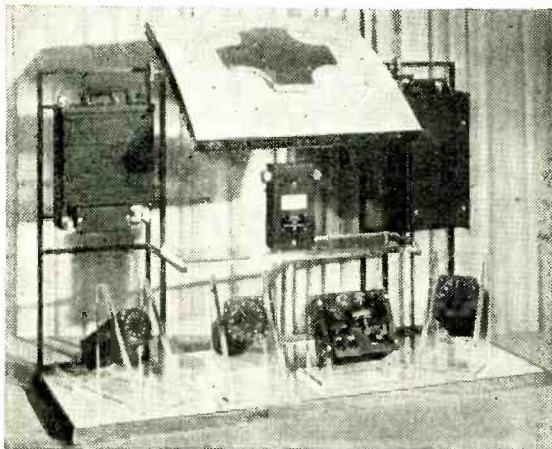

THE illustration shows the various units that comprise the latest Marconi sub-miniature automatic direction finder for use in aircraft. It weighs complete 23 lb only and is based on the well-known Bellini-Tosi system using fixed crossed loops, in this case wound on ferrite cores, and a goniometer search-coil embodied in the bearing indicator. The goniometer is motor driven and automatically displays the radio bearing. Tuning-in of stations is manual and all control is carried out from a small unit. Alternative bearing indicators are available; both are shown here. The frequency coverage is 200 to 1,700 kc/s in three ranges.

Proceedings of the National Electronics Conference, Vol. X. Collection of papers covering a wide range of subjects including microwaves, servo-mechanisms, solid-state devices and information theory. Pp. 808+XIV; Figs. 447. Price \$5. National Electronics Conference, 84E, Randolph Street, Chicago, 1, Illinois, U.S.A.

Technique et Applications des Transistor by H. Schreiber. Physical principles, methods of construction and circuitry of point and junction types, with an analytical appendix treating the transistor as a four-pole network. Pp. 157; Figs. 182. Price Fr.720. Editions Radio, 9, rue Jacob, Paris, 6.

Principles for Television Advertising. Code of standards based on recommendations of the Advertising Advisory Committee for the guidance of prospective advertisers on television. Pp. 15. Price 1s. Independent Television Authority, 14, Princes Gate, London, S.W.7.

Staging TV Programmes and Commercials by Robert J. Wade. Illustrated treatise on the stagecraft of television programme production. Materials and methods of scene painting and lighting. Pp. 216. Price 48s. Chapman and Hall, Ltd., 37, Essex Street, London, W.C.2.

Specialized Tape Recorder Manual, Vol. 1. Collection of American manufacturers' service data on popular models made since 1950. Pp. 286, profusely illustrated. Price \$4.50. John F. Rider, Publisher, 480, Canal Street, New York, 13.

From the Electron to the Superhet by J. Otte, Ph. F. Salverda and C. J. van Willigen. Course of instruction for training servicemen, in 42 lessons, with questions and model answers. The authors are in the Service Department of Philips, Eindhoven. Pp. 700; Figs. 733. Price 55s. Cleaver Hume Press, Ltd., 31, Wrights Lane, London, W.8.

Photo-electric Handbook by G. A. G. Ive. Practical guide to the installation, operation and maintenance of equipment incorporating photo-emissive cells. Pp. 152; Figs. 108. Price 17s 6d. George Newnes, Ltd., Southampton Street, London, W.C.2.

Zilveren-Jubileumboek K.V.I.V. Report of the International Technical-Economic Congress held under the auspices of the Royal Flemish Engineers Association at Antwerp in June, 1954, containing eighty-five papers on civil, mechanical and electrical engineering developments ranging from harbour works to automatic process control. Pp. 644; profusely illustrated. Price 1,000 Belgian francs. Technisch-Wetenschappelijk Tijdschrift, Torengewouw VIII, Schoenmarkt 31, Antwerp.

VACATION COURSE FOR TEACHERS

THE Ministry of Education, in conjunction with the Radio Industry Council, is to conduct a course for full- and part-time teachers of radio and television servicing and of radio in telecommunications engineering courses.

The course, at Northampton Polytechnic, London, is from July 17 to July 27. Further details may be obtained from the Ministry of Education (Teachers' Short Courses), 36-38, Berkeley Square, London, W.1.

NEW MATERIALS HANDLING JOURNAL

THE first issue of a new controlled-circulation quarterly, *Materials Handling News*, dealing with all types of labour-aiding machinery will be published on July 1 by *Mechanical Handling*, the journal which organizes the Mechanical Handling Exhibition.

Materials handling, properly applied, can benefit all industries large and small, yet many firms are still not making the maximum use of the equipment available; it is to such people that *Materials Handling News* is addressed.

The first issue will appear on July 1; those wishing to receive copies should write to Dorset House, Stamford Street, London, S.E.1.

Radioactive Aids for Industry

Establishment of a New Research Group at Harwell

THE problem of disposing of radioactive by-products from nuclear reactors is not likely to present any difficulty for many years to come, as the demand for sources of radiation by industry is at present greater than the supply. Many chemical reactions proceed with greater facility in the presence of radiation, e.g., the polymerization of ethylene, and the "vulcanization" of rubbers, particularly those of the silicone type.

Improvements can also be effected in the end-products, and the increased heat resistance of irradiated polythene is already engaging the attention of cable makers.

In our own field it has been found* that irradiation of transistors can reduce the recovery time and in-

crease the speed of operation under pulse conditions, as, for example, in calculating machines.

To explore the widening field of application for radiation sources and to help users to make the best use of the supplies which will soon be available, a Technological Irradiation Group has been formed at Harwell by the United Kingdom Atomic Energy Authority. Research will be carried out not only with the "gross fission products" (and specially extracted elements such as caesium 137 and strontium 90), but with the intense radiations which will be available from uranium fuel rods during the storage period after removal from reactors and before chemical processing to separate the uranium and plutonium. The Group will also be equipped with van de Graaff accelerators for general research into irradiation problems.

* Florida, C. D., Holt, F. R. and Steven, J. H. *Nature*, February 27th, 1954, Vol. 173, p. 397.

I.T.A. COVERAGE TESTS

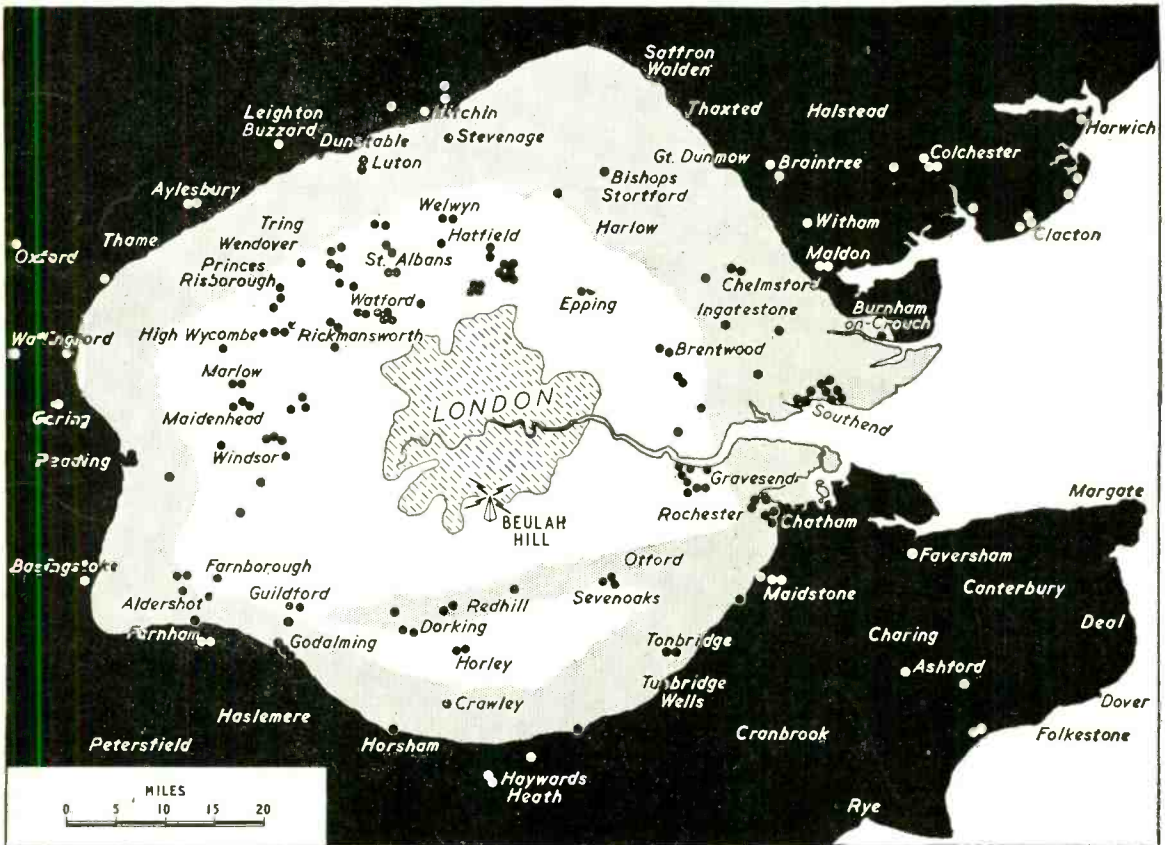

Reports received by Belling & Lee of reception of their experimental 1-kW transmitter G9AED on the I.T.A. site at Croydon are summarized by the dots on this map. They indicate where properly "locked" pictures have been obtained, and at all such points it is expected that reception will be good on the future I.T.A. transmissions. A great many reports were naturally received from the central London area, but these have been omitted for the sake of clarity. The map is based on the I.T.A. one released earlier in the year (April issue, p.154) and shows the estimated coverage of the 60-kW temporary transmitter now under construction in terms of a primary service area (white) and a secondary service area (shaded). Although there are dots beyond these areas, it must not of course be expected that everyone "in the black" will get good reception.

WORLD OF WIRELESS

Organizational, Personal and Industrial Notes and News

I.T.A. Northern Stations

AS foreshadowed in our March issue I.T.A. has found it necessary to use two transmitters operating in Band III to cover Lancashire and Yorkshire instead of one as is done by the B.B.C. in Band I.

The first of the two sites to be chosen is on Winter Hill, Rivington Moor, some five miles north-west of Bolton. A 450-ft mast, now under construction at Marconi's, who are also providing the transmitting equipment, will be erected on the site which is 1,450ft above sea level. Coverage is expected to extend in the north to Barrow-in-Furness, south to Stoke-on-Trent and west to Colwyn Bay. Eastwards the coverage will be limited by the ridge of the Pennines.

It is planned to have the station operating with an e.r.p. of 100 kW by the spring of next year. The e.r.p. will eventually be increased to 200 kW.

The probable site for the Yorkshire station is Ovensden Moor, near Halifax, but no decision had been announced at the time of going to press.

Northern Electronics Show

OVER fifty exhibitors, including commercial firms, Government establishments, universities, hospitals and research associations, will be present at the tenth annual electronics exhibition to be held by the Institution of Electronics (Northern Division) at the College of Technology, Manchester, from July 14th to 20th. The opening ceremony will be performed at 2.30 p.m. on the first day. Equipment to be shown ranges from colour television to location of thunderstorms, from computers and counters to electrostatic depositing of flock, from timing loom operations to measuring sound produced by fluorescent lighting chokes, and also includes a good deal of conventional test gear. A programme of forty lectures and sixteen film shows on electronic subjects will be running concurrently with the exhibition.

Admission tickets can be obtained by forwarding a stamped addressed envelope to the Institution secretary, W. Birtwistle, at 78, Shaw Road, Thornham, Rochdale. Catalogues (2s including postage) and lecture and film show programmes (4½d including postage) are also available.

Swedish Television

THE Swedes hope to start up a regular television service on July 1, 1956. A total of some 50 transmitting stations is planned: one of 100 kW, 28 of 60 kW, two of 10 kW, eight of 3 kW and 11 of 1 kW.

A large demand is expected for foreign equipment such as studio and camera equipment, booster-station installations, coaxial cables, radio links and, at the outset, for receiving sets. The Swedes will use the 625-line system and 25-picture frames per second.

At present there is a 5 kW station operating from the Technical High School in Stockholm with a weekly experimental programme.

It is estimated by the Swedish committee planning

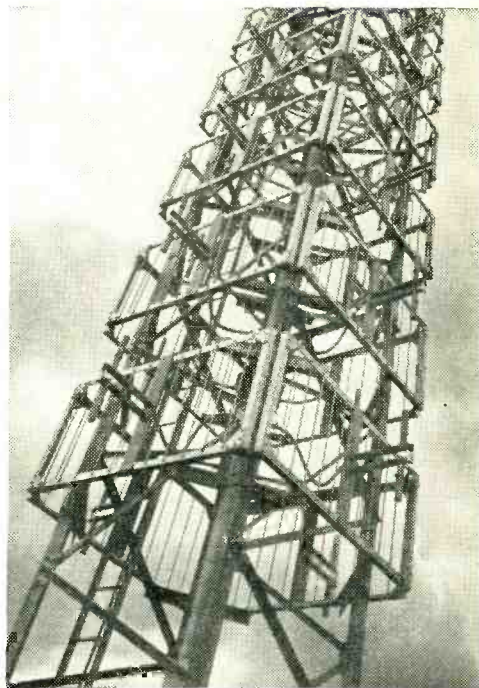

I.T.A. AERIAL. Part of the 8-stack aerial array built by Marconi's for the I.T.A. Croydon station.

the future of television that within 14 years of the inauguration of regular services there will be nearly a million licence-holders in Sweden.

Thoughts on Broadcasting

SOME points made by Harold Bishop, director of B.B.C. Technical Services, in his inaugural speech as president of the Radio Industries' Club:—

V.H.F. Broadcasting.—We are delighted by the positive steps the industry has taken to get it started; already over 50,000 sets have been distributed.

Interference.—There is danger in over-simplifying the design of television receivers. Interference from line time bases is a serious blot on the copybook of the industry.

Colour.—We are going to do some experiments, but in my opinion it will be a long time before there is any colour television service in this country.

Receiving Aerials seem to need a great deal of attention. An integrated design [for all broadcasting] is needed.

Eurovision.—The number of television receivers in Europe outside the United Kingdom is under half a million. Bear this in mind when talking about programme exchanges.

Manpower.—Not enough is being done to encourage young chaps to join electronics; we want the help of science masters in schools.

PERSONALITIES

Rudolf Kompfner, who came to this country from Austria in 1934 and since 1952 has been in the United States working on microwave valves at the Bell Telephone Laboratories, New Jersey, is to receive this year's Duddell Medal from the Physical Society. It is being awarded in recognition of his work in this country on the travelling-wave valve of which he was the originator. He described the valve in our November, 1946, issue. During the war he was a temporary experimental officer in the Admiralty (undertaking research in the Physics Department of Birmingham University), and in 1944 went to the Clarendon Laboratory of Oxford University where he stayed until going to the United States.

The degree of D.Sc.(Eng.) has been conferred by the University of London on **Dr. A. Rosen**, Ph.D., M.I.E.E., for his work in the field of telecommunication cables. Dr. Rosen, who has been consultant engineer (telecommunications) with British Insulated Callender's Cables, Ltd., since 1953, was formerly chief engineer (telecommunication cables) with Siemens Brothers. He has written a number of papers on r.f. cables, some of which have appeared in our sister journal *Wireless Engineer*.

Robert L. Green, A.M.I.E.E., has joined Winston Electronics, Ltd. (who have recently moved to Shepperton, Middx.) as senior development engineer responsible for telecommunications research and development. Born in Holland, Mr. Green, who is 33, came to this country during the war and was with the General Electric Company at Shaw, Lancs, before joining Standard Telephones and Cables in 1943. During his nine years with S.T.C. at Footscray, Kent, he was concerned with the design and development of machinery for the production of valves.

The superintendent of the new Electronics Department of Metropolitan-Vickers, at Trafford Park, Manchester, is **E. T. W. Barnes**, who has been, since 1953, superintendent of the radio department (which is incorporated in the new department). He joined the company as a college apprentice in 1930. The assistant superintendent of the department is **D. E. Thornhill**, B.Sc.Tech., Grad.I.E.E., who joined the company as a vacation apprentice in 1936. **Dr. L. W. Brown**, B.Sc., Ph.D., M.I.E.E., F.Inst.P., who has been chief engineer of the radio department since 1950, is chief engineer of the new department. He was with B.T.-H. from 1943 to 1950, where he was responsible for radar development, prior to which he was for three years a scientific officer at T.R.E., Malvern. **T. R. Goode**, now assistant chief engineer of the electronics department, formerly held the same position in the radio department. **J. L. Russell**, A.M.I.E.E., who since 1947 has been in the company's electronic control engineering department, becomes assistant chief engineer (special applications) in the new department. **L. H. J. Phillips**, who is appointed sales manager of the department, was at one time during the war head of the radio department of R.A.E., Farnborough, and subsequently became deputy director of communications development in the Ministry of Aircraft Production. He has been sales manager of the Metrovick radio department since 1945.

E. Cattanes, B.Sc., M.Brit.I.R.E., has joined the Solartron Electronic Group, Ltd., Thames Ditton, Surrey, as a senior commercial executive. In 1934 he started and managed in Paris the French subsidiary of A. C. Cossor, Ltd., and in 1937 he managed the newly formed Cossor Instruments Division in London, being responsible for introducing, in 1938, the double-beam oscillograph. After periods of service with Airmec, Ltd., and the English Electric Company, he went to Canada in 1952 and returned to this country at the end of last year. Mr. Cattanes has twice been a member of the Council of Brit.I.R.E. and from 1948 to 1952 was chairman of the industrial electronics section of the Radio Communications and Electronic Engineering Association.

D. H. W. Busby, whose article giving the design for a pre-amplifier appears in this issue, has been with Mullard for the past five years, prior to which he was for 2½ years in R.E.M.E., where he was working on gunnery control equipment. While with Mullard he has been concerned with problems encountered in the production of cathode-ray tubes and more recently with valve applications especially on the audio side.

F. W. Hollings, who has been with the Dubilier Condenser Company for 36 years, has retired from the position of secretary and has been appointed a director. He is succeeded by **H. S. Clemow**.

Victor G. Oastler, who has been in charge of the Marconi Marine Aberdeen depot since 1948, has been transferred to the main London depot (East Ham) where he will be deputy manager until the retirement in September of the present manager, C. T. Sanders. Mr. Oastler joined Marconi's as a sea-going operator in 1929. The new manager at Aberdeen is **Alexander P. Goodman**. After sixteen years' duty at sea he joined the technical staff in Bombay in 1942 and became an inspector there in 1949. The new manager of the company's Port Said service depot is **George A. Dwyer**. He joined the company in 1929 and after 12 years at sea was appointed to the shore technical staff.

BIRTHDAY HONOURS

A baronetcy is conferred upon **Sir George Nelson**, head of the English Electric-Marconi group of companies.

Harold Bishop, director of B.B.C. Technical Services, receives a knighthood.

Appointments to the Order of the British Empire include:—

Hugh K. Grey, head of the communications department, Foreign Office (C.B.E.).

F. Neil Sutherland, general manager, Marconi's Wireless Telegraph Company (C.B.E.).

Philip H. Spagnoletti, director and general manager, Kolster-Brandes, Ltd. (O.B.E.).

Harold W. Cox, E.M.I. Engineering Development, Ltd. (M.B.E.).

Richard W. Lewis, chief chemist, Burndep, Ltd. (M.B.E.).

Robert J. Parker, senior telecommunications superintendent, Cable and Wireless (G.P.O.), Birmingham (M.B.E.).

Recipients of the British Empire Medal include **Sydney F. Alexander**, technical officer, Post Office Research Station, Dollis Hill; **William D. H. Lockerby**, technical officer, Radio Telephony Terminal, G.P.O.; and **Harold Robertson**, radio technician, No. 20 Maintenance Unit, R.A.F.

IN BRIEF

The number of broadcast receiving licences current in the U.K. passed the **Fourteen Million** mark during April. At the end of the month the total was 14,017,447, of which 4,580,725 were for television—an increase of 76,959 during the month.

V.H.F. Demonstration.—Although the B.B.C. has at its disposal the means of propagating information to over 95 per cent of the population, it cannot demonstrate to its listeners the advantages of v.h.f. broadcasting. In order, therefore, to bring to the notice of listeners in the London area the benefits of the new v.h.f. service, a special demonstration using comparative recordings has been arranged at the Science Museum, which is open on weekdays from 10 to 6 and on Sundays from 2.30 to 6.

The report of the **Institute of Physics** for 1954 records that the membership was 4,749 at the end of the year. It also records that of the 54 candidates who sat for the newly established Graduate examination, only 19 were successful. The number of candidates taking the final

examinations for National Certificates in Applied Physics was 206 at the Ordinary level and 75 for the Higher Certificate, compared with 151 and 55, respectively, in 1953.

At the recent Diamond Jubilee celebrations of the **Birmingham College of Technology** a number of associate-ships of the College were awarded. Among those to whom associatships were presented by C. F. Partridge, head of the Department of Electrical Engineering, were John M. Beddoes, radar research engineer, Decca Radar; Trevor H. Robinson, graduate apprentice, Marconi's; Kenneth J. Adderley, graduate apprentice, G.E.C.; and Michael J. Hampton, student apprentice, G.E.C.

In a statement summarizing the work of the **Professional Appointments Bureau** (9, Victoria Street, London, S.W.1) it is recorded that in 1954 it submitted particulars of over 9,000 engineers for vacancies in civil, mechanical and electrical engineering. Incidentally, the majority of electrical vacancies called for experience in electronics and light current engineering.

The annual report of the **Radio Industries Club** records an increase in membership of 33 during the year, bringing the total at the end of March to 874. Harold Bishop, director of B.B.C. Technical Services, who has been a member of the Club since 1943, succeeds C. O. Stanley (Pye) as president. Frank Jones (Marconiphone) and F. H. Robinson (Odhams) are respectively chairman and vice-chairman.

Gift of Test Gear.—A complete set of 10-cm test equipment was recently presented to the Kingston-on-Thames Technical College by Decca Radar, Ltd. It will be used as part of the normal laboratory programme for full-time Higher National Diploma and B.Sc. (Eng.) degree courses and for post-graduate courses in microwave and pulse technique. The presentation was formally made by S. R. Tanner, the company's director of research.

Standard TV Set.—According to information published in the *E.B.U. Bulletin*, the German television set manufacturers have agreed to produce, in addition to their own individual models, a standard receiver with a 43 cm (17in) tube, priced at about D.M.700 (£60).

L.C.C. Mobile Radio.—Although in London few places are more than two miles from an ambulance station, the L.C.C. is introducing, experimentally, a radio-telephone service for its ambulances. Six ambulances and a staff car are to be equipped and a headquarters station set up at a cost of £2,975.

1955-56 Prospectus.—Details of full-time day courses in telecommunications engineering and servicing, one-day-per-week courses organized at the request of the Radio Industry Council and evening classes in telecommunications engineering, servicing and one or two specialist courses are given in the new prospectus sent to us by the Northern Polytechnic, Holloway, London, N.7.

B.R.E.M.A. Council.—We were misinformed as to the representative of English Electric on the Council of B.R.E.M.A. (see page 256 of our last issue). H. C. Timewell represents the company and not D. C. Spink who is no longer with English Electric.

The aggregate attendance during the ten days of the recent **Northern Radio Show**, at City Hall, Manchester, was 90,385.

Audio Convention.—The 1955 convention of the Audio Engineering Society of America will be held in the Hotel New Yorker, New York, from October 12th-15th and will run concurrently with the annual Audio Fair.

At the end of its first year the **India Institution of Telecommunication Engineers**, New Delhi, had more than 1,000 members. The publication of a quarterly journal has been started.

A reader has a number of back issues of *Wireless World* (August, 1949, to June, 1953) which he is willing to give to a club. Requests should be addressed to B. F. H., care of the Editor.



IS THIS AN IDEA for the G.P.O.? The Belgian postal authorities are now using the cancellation stamp to popularize television.

PUBLICATIONS

Abstracts of all new **British Patents**—whether of U.K. or foreign origin—are given in *Patents Abstracts Journal* which is published weekly by the Technical Information Company, of Liverpool. There is a subject index of short titles for each of the three main groups—general and mechanical; chemical; electrical—and it is claimed that the information is published within ten days of the patents being available for public inspection. The complete journal costs £26 a year but each of the sections is available separately.

Plastics Materials.—A new 62-page booklet, which lists alphabetically, according to chemical type, plastics materials and their manufacturers, is issued by the British Plastics Federation. A short note on the outstanding properties is given as a preface to the section devoted to each type of material. The booklet, "Buyers' Guide to Plastics Materials and Machinery and Equipment for the Plastics Industry," is obtainable from the Federation, 47-48, Piccadilly, London, W.1, price 2s 6d.

A proper system of book-keeping is essential to even the smallest business; we do not apologize, therefore, for bringing to readers' notice an authoritative book on the subject issued by our publishers. "**Book-keeping for Small Traders**," by J. Unett, is published by Iliffe and Sons Ltd., price 12s 6d. (Postage 4d.)

We understand from the R.S.G.B. that it is now able to supply from stock the 1955 **A.R.R.L. Handbook** (mentioned in our May issue, page 246).

Appendices dealing with the **Suppression of Interference** caused by flasher signs are included in the revised edition of the British Standard "Electric signs and high-voltage luminous discharge-tube installations" (BS559, price 5s).

INDUSTRIAL NEWS

In his review of the year, Viscount Chandos, chairman of **Associated Electrical Industries, Limited**, of which B.T.H., Edison Swan and Metropolitan-Vickers are members, stated that a new factory designed specifically for the production of Ediswan cathode-ray tubes was being built at Sunderland. When this is brought into use later this year it will release space at the Brimsdown factory for advanced development of tubes for coloured television. Viscount Chandos also stated that a new electronics factory is planned for B.T.H.

Another factory at Hove has been acquired by **Mullard** for the assembly of valves and cathode-ray tubes. At the present factory at Wilbury Villas, which employs about 175 people, and at the new factory at Cromwell Road, which will accommodate up to 350, the valves are made from sub-assemblies produced at another of the firm's thirteen factories.

A. Jennings of **Murphy Radio, Limited**, has accepted an invitation to serve on the 16-member Statutory Advisory Committee of the Board of Trade concerned with the preparation of forms and instructions for a sample census of distribution and other services for 1956.

Marine Exhibition.—A number of manufacturers of radio communication equipment and electronic aids to navigation are participating in the Engineering, Marine and Welding Exhibition which is to be held at Olympia, London, from September 1st to 15th.

In order to associate its name more directly with its specialized manufacture of high vacuum equipment, the title of **W. Edwards and Co. (London), Limited**, of Manor Royal, Crawley, Sussex, has been changed to **Edwards High Vacuum, Limited**.

A model of the new laboratory planned specifically for developing colour television by **Sylvania-Thorn Laboratories, Limited**, was shown at the Summer Exhibition of the Royal Academy in London. The laboratory will be built on the Great Cambridge Road, Enfield.

A travelling display of cables and wires and various materials used for insulation has been put into service by **British Insulated Callender's Cables, Limited**, and is touring the United Kingdom. During July it will be in London and the Home Counties.

A hand-held underwater television camera and associated equipment has been supplied by **Pye Canada Limited** for the arctic survey to be undertaken by H.M.C.S. *Labrador*.

Cossor Instruments, Ltd., formerly the instrument division of A. C. Cossor, Ltd., has been incorporated as a subsidiary company in the Cossor group.

Sound Sales, Ltd., inform us that their application for the registration of the trade mark "A-Z" has been accepted by the Patent Office.

The new headquarters of the **General Electric Company, Limited**, Midland sales organization, was recently opened at Magnet House, Newhall Street, Birmingham. It has a radio and television service department. The G.E.C. has also opened new premises in White House Road, Ipswich.

The Scottish Service Department of **E. K. Cole, Limited**, has been transferred from 26, India Street, to 17, Cadogan Street, Glasgow, C.2 (Tel.: Central 3633).

Winston Electronics Limited have moved from Hampton Hill to their new factory and offices in Govett Avenue, Shepperton, Middlesex (Tel.: Walton-on-Thames 2732).

Recent additions to the ever-growing number of organizations using mobile radio-telephone equipment include paper merchants and laundries. **Pye** are supplying the radio equipment for forty vehicles used by Phillips, Mills and Company for the collection of wastepaper in Greater London, for eight vehicles used on the 400-acre site of the paper mills of Albert E. Reed and Co., at Aylesford, near Maidstone, and for three of the vans used by Wigmore Laundries, Limited, of Shepherds Bush, London. **Pye** have also received orders from the Dorset and Carmarthen county ambulance services for eleven and twenty mobile installations, respectively, together with a fixed station for each.

I.T.A. MIDLAND TRANSMITTER.—This is the **Pye** equipment to be installed at the I.T.A. Midland television station to be built at Common Barn Farm, Hints, some five miles south-east of Lichfield, Staffs. It is estimated that its service area will extend as far south as Gloucester, to Chesterfield in the north, Shrewsbury in the west and Market Harborough in the east. Initially the station will have an e.r.p. of 100 kW, eventually to be increased to 200 kW. The mast and aerial system are being supplied by **Marconi's**.

EXPORTS

Increasing Radio Exports.—Provisional figures issued by the Radio Industry Council for exports during April show a further increase. The month's figure was £2,969,213. This brings the total radio exports for the first four months of the year to over £10.5M which is an increase of more than 10 per cent on the same period last year.

The **Companhia Telefonica Brasileira** (Brazil's tele-communications organization) has placed contracts for the supply of equipment for a cable and radio network for multi-channel telephony with **Standard Telephones and Cables, Limited**, through the associated company **Standard Electrica S.A.**, of Brazil. The network of radio links, operating on a frequency around 4,000 Mc/s, covers some 300 miles in thirty-mile hops. Seven radio channels in each direction are provided and each of these can carry up to 600 telephone circuits.

Of the twenty-four British and foreign manufacturers who submitted tenders to the Egyptian Police Authorities for the supply of equipment for an extensive radio network, **Marconi's** have been awarded the contract. It provides for the supply of 221 v.h.f. mobile stations and 132 transmitters and 139 receivers for fixed stations. In addition, an inter-city h.f. system has been planned involving the supply of twenty-four 500-watt transmitters, associated h.f. receivers and receiving terminal equipment. **Marconi's** are also providing masts, aerials and ancillary gear.

E.M.I. Electronics, Limited, of Hayes, have supplied to the **Compania Shell de Venezuela**, in Caracas, a console control desk providing for four microphone inputs and eight line inputs and a transportable 4-channel mixer unit. The control desk will be used to feed programme material from various sources to a film recording unit and to tape and disc recorders. The **Shell Company** provides films and film material for regular programmes from two Venezuelan television stations.

Representation of United Kingdom manufacturers of industrial and medical electronic equipment and television components and accessories is sought by B.I.B. (Belgium-Ireland-Britain), S.A., 21 rue Defacqz, Brussels, Belgium.

United Motor and Electrical Company, of 387, Skinners Road South, Colombo, Ceylon, ask to be put in touch with manufacturers of a.c. and d.c. test and measuring instruments.

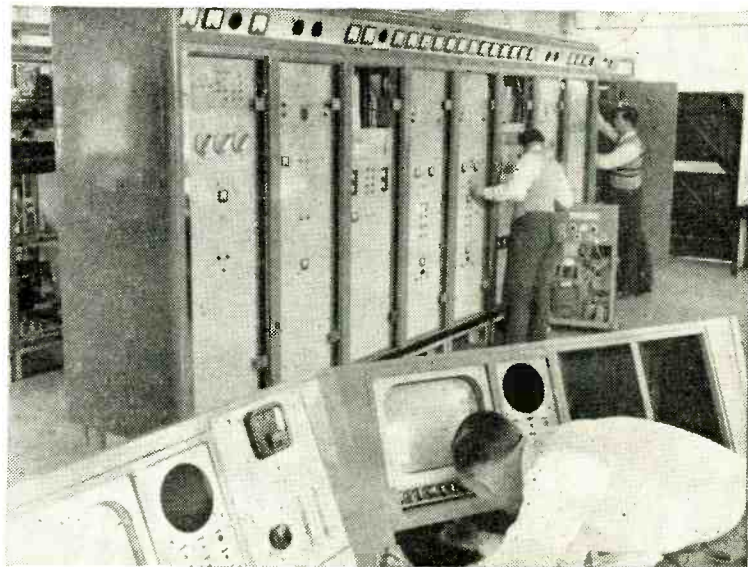

Developments in Sound Reproduction

NEW PRODUCTS AND TRENDS AT RECENT EXHIBITIONS

AT least two London exhibitions in the late spring—those organized by the British Sound Recording Association and by the Association of Public Address Engineers—are devoted exclusively to sound reproduction, and a third, the Radio and Electronic Component Manufacturers' Federation's show, can always be relied upon to include a substantial proportion of electro-acoustic components. The following notes are gleaned from visits to all three exhibitions and give some idea of the activities which have reached fruition in the development departments of the firms exhibiting.

Microphones.—An interesting transmitter-microphone, operating without trailing leads, has been developed by Leavers-Rich for use in film production and broadcasting. It measures only $4\frac{3}{4}$ in \times 1 in \times $\frac{1}{2}$ in and can be clipped into the breast pocket, when the $\frac{3}{8}$ -in diameter condenser microphone resembles the projection of a fountain pen top. (Alternative forms are available.) The transmitter, which has an output power of 5 mW, operates at 70 Mc/s and is energized from miniature batteries. The condenser microphone is omni-directional and the effective frequency range is 30–10,000 c/s. At the receiver, which is a.c. operated and takes the form of a 19-in rack unit, a limiter controls the variations of r.f. level due to movement of the transmitter for input signals above 1 μ V.

Another unobtrusive microphone, this time of normal direct-connected type, is the Model LFBV59 "Full Vision" made by Lustraphone. This has been designed for singers and other artists and measures only about 1 in in diameter. It is of the moving-coil type and is suitable for hand or stand use.

The trend towards smaller physical dimensions is also seen in the M7 moving-coil and M8 ribbon microphones made by Film Industries. These measure respectively $2\frac{1}{2}$ in and $1\frac{3}{8}$ in in diameter and make use of semi-flexible tubing instead of swivel joints for adjusting the angle of the head.

The Reslo ribbon microphone is now available in a redesigned screen with matching transformer in the base. The ribbon is 2 microns in thickness and is die formed to a shape which gives visual indication when the designed tension has been applied. This microphone, and the Reslo miniature moving coil, are characterized by the ingenuity of the mechanical design, which combines a high electro-acoustic performance with ease of assembly and positive alignment.

Pickups.—The Leak "Dynamic" (moving-coil) pickup has been retooled for mass production at a reduced price, with an improved performance over the original model. Playing weights are 2 to 3 gm on $33\frac{1}{2}$ r.p.m. records and 5 to 6 gm 78 r.p.m. shellac records. The damped high-frequency resonance is 20 c/s \pm 5 c/s and a level response \pm 1 db is claimed from 40 c/s to 20 kc/s. A diamond stylus is standard on both the long-playing and 78 r.p.m. heads.

In a new Cosmocord high-output turnover crystal pickup, replaceable flat strip cantilevers are used for

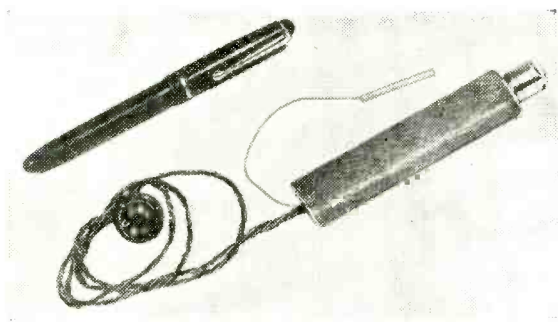

Leavers-Rich "Radiovoyce" transmitter-microphone.

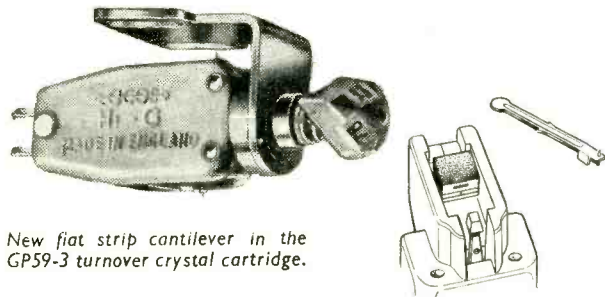

New flat strip cantilever in the GP59-3 turnover crystal cartridge.

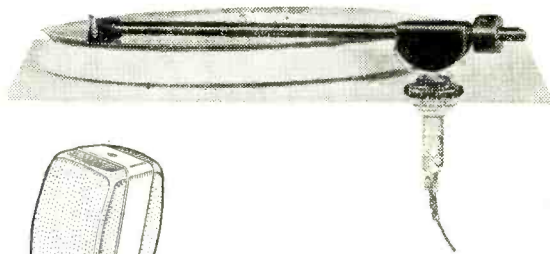

Leak "Dynamic" moving-coil pickup.

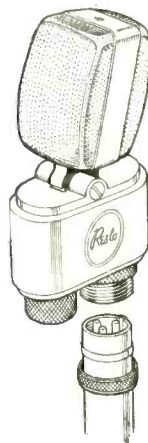

Reslo ribbon microphone.

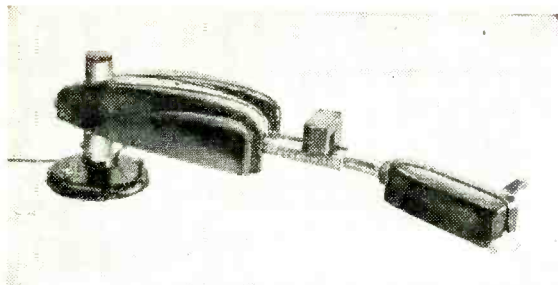

Goldring transcription pickup arm.

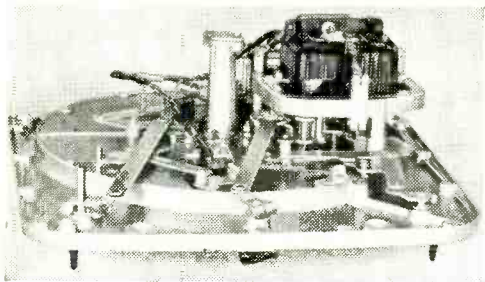

Underside of Garrard "301" transcription motor.

each stylus. The type GP59-3 has a Rochelle Salt element and a tropical version, GP61, is available with a barium titanate element. A special head, HGP55, has been introduced for the Burne-Jones pickup arm with the correct dimensions for minimum tracking error.

Precise adjustment of playing weight with a calibrated scale is provided in a new "transcription" pickup arm developed by Goldring. No springs are used and the counterbalance is effected by variable leverage.

A new record for the testing of fine-groove ($33\frac{1}{3}$ r.p.m.) pickups is available from the British Sound Recording Association, 295, Regent's Park Road, London, N.3. It carries fourteen frequencies between 50 c/s and 10kc/s and the lateral velocities conform within 0.5 db to the CCIR standard combining a 450 μ sec bass cut with a 50 μ sec top lift. The recorded velocity at 1,000 c/s is 1 cm/sec.

Gramophone Motors.—The Model 301 variable-speed a.c. mains transcription turntable is now in quantity production and the final design incorporates many detail refinements. In addition to resilient mounting of the driving motor, all controls, and even the mains leads, are spring-mounted to isolate the turntable from all sources of vibration. Speed variation is by means of a magnetic brake.

Designed for professional "dubbing" work, the Connoisseur (Sugden) variable 3-speed motor, recently introduced, employs a synchronous driving motor running at constant speed, and a variable reduction drive gives a range of 2% on any of the three speeds.

R.F. Tuners.—The establishment of the v.h.f. sound service has redirected the interest of high-quality enthusiasts to the potentialities of B.B.C. programmes, and a number of f.m. tuners suitable for connection to high-quality amplifiers are now available.

Permeability tuning in conjunction with temperature-compensating capacitors, and an i.f. limiting stage as well as a ratio detector to discriminate against a.m.

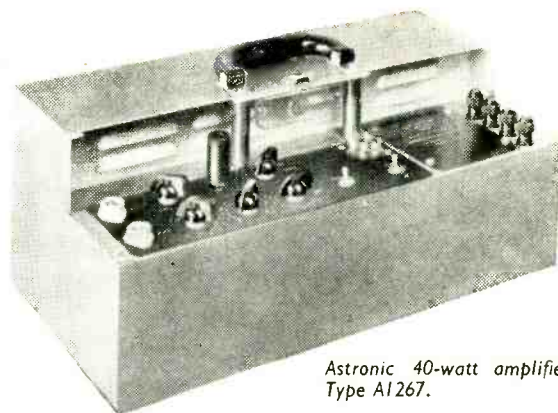

Astronic 40-watt amplifier, Type A1267.

interference are features of the Armstrong Model FM56.

The Acoustical Manufacturing Company's f.m. tuner, in its redesigned form, incorporates a unique tuning indicator in which two small neon lamps show at a glance when the station is in tune, or whether it is mistuned to the right or left of the correct setting. A frequency error of 1 part in 10,000 is detectable. Adjustable station indicators are provided, and the frequency range of 87.5 to 108 Mc/s covers both British and American v.h.f. broadcast bands.

In addition to the Type FM81 variable-tuned unit C. T. Chapman (Reproducers), Ltd., have introduced a three-station version (FM82) with switch selection of the Light, Home and Third programmes of the B.B.C. Each pre-tuning trimmer has a range of 88-100 Mc/s. A tuner unit with facilities for both f.m. at v.h.f. and amplitude modulation on other wavelengths is also available from this firm for the many people who are interested in world-wide reception. Two versions are made, Type S5/FM, with medium, long and one short-wave range, and Type S5E/FM, with three short-wave ranges and the medium waves in addition to the 87.5-100 Mc/s range for f.m.

Amplifiers.—The prototype of a transistor amplifier with an output of 10 watts was shown by Lustraphone. It uses two Mullard experimental power transistors in the output stage and is claimed to have a substantially flat response from 50 c/s to 10,000 c/s. A small 12-volt accumulator is recommended for the power supply and the current drain is 1.5 A at full output (0.25 A quiescent). The dimensions of the case are only 6in \times 4in \times 4in.

The "Astronic" range of portable p.a. amplifiers made by Associated Electronic Engineers, Ltd., is notable for the convenient arrangement of the controls on a horizontal surface, and for the strength and rigidity of the steel carrying case. Model A1267 is for mains or battery operation and has a built-in vibratory converter. The power output is 40 watts.

The new Lowther amplifier (Type TP10) makes use of the latest Mullard EL34 output valves in a triode-pentode method of connection. The output impedance is less than 0.4 ohm and a damping factor of 40 is claimed over the frequency range of 7c/s to 70,000 c/s. Another new Lowther product is a variable low-pass filter with a cut-off at 18 db/octave continuously variable between 2 and 20kc/s. It is designed to work with most high-quality amplifying equipments.

Detail improvements in the Rogers range of ampli-

fiers include an "ultra-linear" output stage and provision for a radio input in the Mk. III version of the RD Minor. The RD Junior amplifier/control unit has a specification which meets most domestic requirements with an output of 8-10 watts, and the RD Senior with 25 watts is suitable for schools and gramophone societies. An interesting detail of the RD Junior is the "impedance plug" loudspeaker matching arrangement. Three plugs for 2-3, 6-8 or 12-16 ohms are provided and the correct value of feedback resistor is selected according to the plug in use.

Whiteley Electrical were showing a new high-quality amplifier and control unit with an output of 12 watts.

In the control circuit of the new Armstrong A10 amplifier, a worthy effort has been made to rationalize the chaotic pick-up equalization situation. Four principal response characteristics cover all the main British, Continental and American recording characteristics, which are listed and grouped. Minor differences are taken care of by the variable tone controls.

Pamphonic have produced a robust 12-volt "loud hailer" in which the amplifier and a rotary converter for h.t. are housed in a weatherproof metal case. Valve heaters are energized in the standby position and a microphone press-switch operates a relay to start the converter before speaking. The power output is 10 watts into a weatherproof re-entrant horn loudspeaker.

Loudspeakers.—A vintage crop of new loudspeakers can be reported this year. Undoubtedly the development which has attracted most interest is the realization that the push-pull electrostatic loudspeaker can be operated in such a way as to remove what was thought to be its inherent non-linearity of transfer characteristic. Indications are that ultimately it may

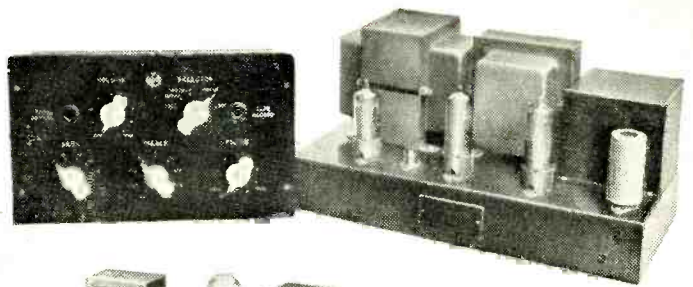

Rogers RD Junior amplifier and control unit.

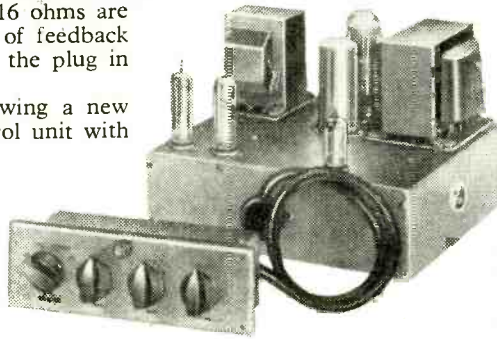

Left: Whiteley Electrical 12-watt high-quality amplifier.

set the standard for other items of sound reproduction equipment as far as harmonic distortion is concerned. H. J. Leak demonstrated a high-frequency electrostatic unit of the new type in conjunction with a

15-in moving coil with a cross-over at 700 c/s, and the prototype of a wide-range all-electrostatic reproducer (40 c/s to 20 kc/s) was shown working by the Acoustical Manufacturing Company.

An interesting new ribbon loudspeaker, which, like the electrostatic is driven over the whole of its radiating surface, has been developed by Kelly Acoustics. By the judicious use of modern magnet materials a flux density of 10,000 gauss has been achieved in the gap, giving a force/mass ratio of 4×10^7 dyne/gm (the diaphragm weighs only 8 milligrams). A "potted" coupling transformer presenting an impedance of 15 ohms is included. The frequency range is 3 to 20 kc/s.

Reslosound, in conjunction with the B.B.C. Research Department, have made a moving-coil direct-radiator loudspeaker unit for the range 2 to 20 kc/s. The spherical diaphragm is of metal and the coil is of self-supporting aluminium. The response is remarkably free from irregularities and the polar response is sensibly uniform over an angle of 90° .

A new 3-in diameter moving-coil "tweeter" is now incorporated in the Wharfedale 3-speaker reproducing system. The cone and coil assembly, which is mounted in a cloth surround and incorporates a centre spherical dome, weighs $1\frac{1}{4}$ gm. The magnet system provides a total flux of 54,000 maxwells and a flux density in the gap of 13,000 gauss. This unit, known as the Super 3, is obtainable separately.

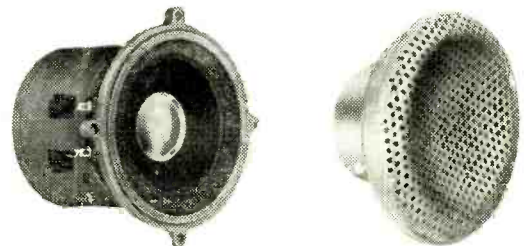
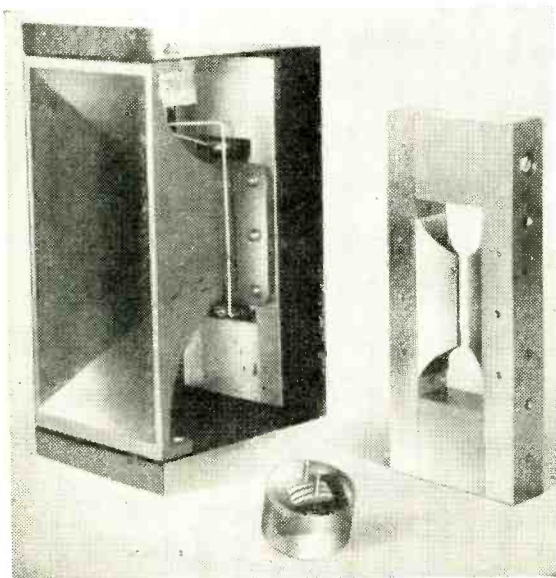

Left: Kelly Acoustics ribbon loudspeaker, with de-mounted magnet system and coupling transformer. Centre: Wharfedale "Super 3" tweeter. Right: Plessey 3-inch inset loudspeaker.

To provide the essentials of the performance of the Guy R. Fountain "Autograph" loudspeaker in more compact and somewhat less expensive form, Tannoy Products have produced the "G.R.F." enclosure with dimensions of 48in x 38in x 29in. A 15-in dual-concentric unit is employed with rear horn loading below 350 c/s and forward horn loading between 350 and 1,000 c/s to preserve a realistic source size on solo vocal and instrumental music, and a spacious distribution on orchestral items with a wider bass response. Above 1,000 c/s the radiation is from the non-directional concentric horn.

The Lowther TP1 corner reproducer, which has already established a reputation for good transient response, has had its performance in this respect still further enhanced by a new field magnet design giving a flux density of no less than 25,110 gauss.

In the Truvox "corner diffusion speaker" internal baffles are used to give a "three dimensional" distribution of output, and the effect is to increase the apparent size of the source.

For studio monitoring, G.E.C. have introduced a high-quality reproducer (BCS1865) consisting of two of their metal-cone units in an octagonal vented cabinet. The unit includes an auto-transformer for matching to 15 ohms.

Two-speaker combinations of any of the units comprising the Goodmans range moving-coil loudspeakers can be arranged in a simple cross-over network using standardized 4.5 mH chokes. Pairs of these chokes for constructing the cross-over unit are available from Goodmans at 37s per pair.

The Plessey 3-in inset loudspeaker, developed in conjunction with S.R.D.E. for Service equipment, is designed to give maximum intelligibility of speech under conditions of high ambient noise, and has maximum sensitivity in the range 800-5,000 c/s. The front of the diaphragm is protected by a perforated steel cover and the materials and finish are chosen to withstand extreme climatic conditions. The unit is available, without the sealed external housing and protective cover, for use in telecommunication equipment.

Magnetic Recording.—An event of considerable importance, particularly to owners of portable recorders with limited spool capacity, is the introduction by the Minnesota Mining and Manufacturing Company of a new thin tape ("Scotch Boy" Type 190M) giving a 50% increase of playing time from any given size of spool. The polyester film base is only 0.001in thick and the coating thickness has also been reduced, but an improved coating material ensures that there will be no reduction in performance.

Much attention is being given to the quality and uniformity of magnetic oxide coatings, not only from the point of view of sound reproduction but also for data recording in computers and for machine control.

Special equipment has been developed by the M.S.S. Recording Company for routine examination of tape production and for the analysis of faults. The tape is driven at 30 in/sec and 10 kc/s is recorded and played back at the full width of the tape. After passing through a 2-kc/s wide bandpass filter the output is rectified and applied as a d.c. component to the vertical deflection of a cathode ray tube. Movement of the spot is photographed on paper travelling horizontally at 1½ in/minute, giving a scale of 1 inch to 100ft of tape. Faults of duration more than 1 millisecond are detectable and the general shape of the curve reveals the qualities of the tape transport

mechanism as well as of the tape itself. Tape intended for pulse data recording is tested by a different technique. The tape is modulated to saturation with square waves equivalent to a pulse density of the order of 200 per inch. On playback, any pulse failing to reach a given level causes a relay to operate and

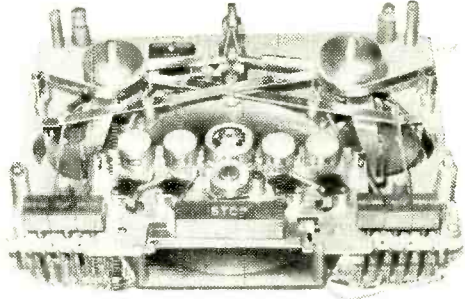

Collaro "Transcriber" tape recording mechanism with and without top cover.

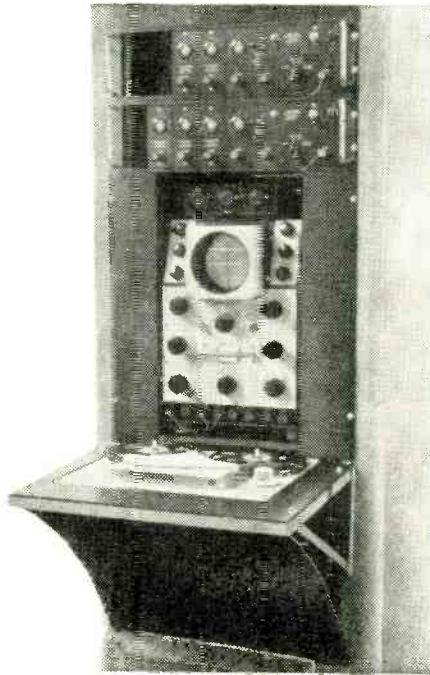

Equipment used by M.S.S. Recording for routine testing of magnetic tape.



Simon SP/2 portable tape recorder.

the tape is stopped. Alternatively the tape can be allowed to run and "drop outs" (tape elements with reduced sensitivity) are then registered on a "Dekatron" counting unit. Other demonstrations arranged by M.S.S. included the so-called Bitter technique for rendering the surface induction visible by applying a colloidal suspension of finely divided magnetite; and a sensitive tensile testing machine for observing changes in length of tape with changes of temperature, humidity, etc.

Collaro break fresh ground with a tape mechanism with many unusual features. Two similar driving motors are employed which are used in turn to drive the capstan. Thus, in conjunction with duplicated erase and record/playback heads, either track of a

reel of tape can be used without changing over spools. An unusually heavy 6 $\frac{1}{2}$ -in-diameter capstan flywheel is used to give constancy of speed, and in addition the wind-on tape tension is held constant by a feeler arm which is coupled to a friction clutch driving the drum. Tension is also controlled on fast rewind. A subsidiary feeler is used to show the amount of tape on the spool. Control is by an interlocked push-button system.

In the new Simon SP/2 portable tape recorder particular attention has been given to accessibility and valves can be changed and adjustments made through inspection covers at the back and side. Two EL84 valves in the output stage give an output of 10 watts, which can be usefully applied to external loudspeakers for p.a. work.

Grundig were showing a "Specialist" version of their tape recorder with a stated frequency range of 50-9,000 c/s at 3 $\frac{1}{2}$ in/sec and 40-14,000 c/s at 7 $\frac{1}{2}$ -in/sec. Track changing is by press-button without changing spools. Wide-angle distribution of sound on playback is achieved by a large elliptical moving-coil loudspeaker in conjunction with two small high-frequency units mounted in the sides of the case.

All Wearite "Tapedecks" now employ synchronous capstan motors and have provision for 1,750-ft reels. Three types are available: A, with normal arrangement of heads; B, with separate record and playback heads for monitoring while recording; and C, with provision for simultaneous dual track recording. A wide variety of complete domestic, professional and industrial recorders incorporating the "Tapedeck" were shown.

Leavers-Rich, who specialize in tape recording for the film industry, television and sound broadcasting and have evolved the "Synchropulse" system of synchronizing sound and film, were showing examples of fine workmanship which included the Model DB2-21C machine. This incorporates its own test equipment for checking frequency response, signal/noise ratio and tape speed constancy. The whole equipment operates from a 12-volt battery, or from a.c. mains when available.

SHORT-WAVE CONDITIONS

Predictions for July

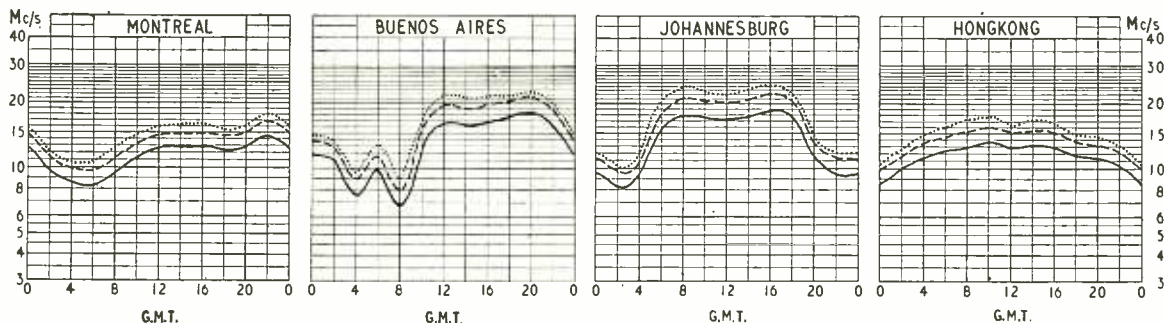

THE full-line curves given here indicate the highest frequencies likely to be usable at any time of the day or night for reliable communications over four long-distance paths from this country during July.

Broken-line curves give the highest frequencies that will sustain a partial service throughout the same period.

- FREQUENCY BELOW WHICH COMMUNICATION SHOULD BE POSSIBLE FOR 25% OF THE TOTAL TIME
- PREDICTED AVERAGE MAXIMUM USABLE FREQUENCY
- FREQUENCY BELOW WHICH COMMUNICATION SHOULD BE POSSIBLE ON ALL UNDISTURBED DAYS

Measurement of

Non-Linearity Distortion

By

M. G. SCROGGIE, B.Sc., M.I.E.E.

Need for a Method Corresponding with Aural Judgment

DESPITE television, interest in sound-reproducing equipment was never greater. For evidence one has only to look at the advertisement pages of this journal. It can hardly be denied however that present practice in specifying the non-linearity of such equipment is unsatisfactory. Out of a considerable number of specifications that were examined, one of them stated the percentage total harmonic distortion at a mentioned power output at two frequencies (40 c/s and 2 kc/s), one gave the same information at a single frequency (1 kc/s), one gave a curve of "total distortion" against watts output (frequency not stated), six gave the "distortion" or "harmonic distortion" or "total harmonic distortion" at a stated output but no stated frequency, two were "undistorted" up to a stated output, and the remainder were even vaguer.

What is the information we really want? Presumably something that will tell us how much unpleasantness we may expect at the maximum output, or alternatively how much output is available up to the point at which unpleasantness does not exceed a specified amount.

The basic principles of this matter have been reviewed so recently by "Cathode Ray" that the preliminaries can be abbreviated. As he says, unpleasantness is not measurable as such, so the only hope of obtaining quantitative information is to find some physical characteristic to which audible distortion is as nearly as possible proportional and measure that. There are of course various types of distortion. Of these, it can be assumed nowadays that frequency distortion can readily be brought under control. The other main type, to which the present discussion will be confined, is non-linearity. Unlike frequency distortion, the results of non-linearity in one unit of the audio chain cannot be compensated by opposite non-linearity in another.

Simple Methods

The problem is to observe and specify non-linearity so as to show how far it causes the reproduction to fall short of perfection. One common method is to apply a sinusoidal signal to the unit under test and to display the output waveform on an oscilloscope, using a linear time base. The fact that this is so often done can only be accounted for, surely, by the comparative ease of the procedure. The degree of distortion can be judged only by comparing what is seen with an invisible mental picture of a perfect sine wave, so the minimum that can be detected depends largely on the experience and skill of the observer and at best is not very small. A considerable improvement is to use a double-beam oscilloscope and compare

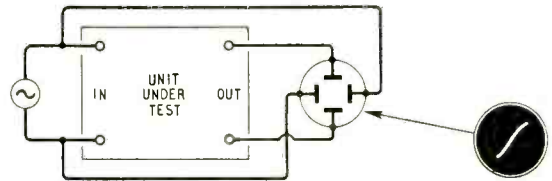

Fig. 1. In this c.r.o. method of measurement the cause rather than the effect of the distortion is seen—the non-linearity of the transfer characteristic.

the output waveform directly with the input, but even then the method is not sensitive enough for nearly linear units. It has its uses, but can hardly be classed as a method of measurement.

Another oscilloscope method is to display the transfer characteristic—the graph of instantaneous output against instantaneous input—by connecting as in Fig. 1. The ideal pattern is a perfectly straight diagonal line. One can much more easily judge departure from a straight line than from a sinusoid, and also more easily distinguish the nature of the distortion. But even so, the method is effective only for what would nowadays be considered comparatively gross distortion.

Need for a Single Figure

Obviously distortion shows up much more clearly if the comparatively large undistorted component of the output is removed. Both simple² and elaborate³ arrangements have been described for filtering out the fundamental output and displaying the remainder—the distortion products—on the oscilloscope screen. This can be a most effective way of investigating distortion. But although distortion oscillograms are extremely informative to any one who can interpret them, for general purposes they have serious disadvantages. They cannot be communicated verbally. They are troublesome to reproduce accurately without photography. And they cannot readily be compared quantitatively with one another, nor enable the signal level to be set to a specific standard of distortion. So the need remains for some method yielding results that can be expressed numerically, preferably as a single figure.

Since the effect of non-linearity is to create signal components or products at frequencies not present in the original, the obvious solution is to compare the amplitudes of these products with that of either the whole output or the undistorted part of it. Stated in this way, the problem looks quite simple, but the more one examines it the more complicated and diffi-

cult it turns out to be. That is, if we have not forgotten that our quest is a measure that corresponds reasonably well with aural judgment.

The first complication arises from the division of distortion products into two classes—harmonics and intermodulation products. This division is a useful one for distinguishing products whose frequencies are multiples of the originals from those with sum and difference frequencies. But it is not such a basic distinction as is sometimes supposed.

The other outstanding question is whether and how the distortion products, if there are more than one, can be combined into a single distortion figure. There is no difficulty in combining as many as one likes, but again one must not forget the aim. Does the combined figure reliably correspond with aural judgment?

Whatever their reasons may be, advertisers of high-fidelity amplifiers seem at present to be in complete agreement on these two matters. If distortion figures are mentioned at all they shall be (1) harmonics and (2) a single figure, viz., total harmonics expressed as a percentage of the whole output⁵. This total is the r.m.s. voltage of all the harmonics together, and the distortion figure is therefore

$$100 \sqrt{\frac{V_2^2 + V_3^2 + V_4^2 + \dots}{V_1^2 + V_2^2 + V_3^2 + V_4^2 + \dots}}$$

where V_1 is the voltage of the fundamental, V_2 the voltage of the second harmonic, and so on. Although this whole expression may look rather complicated*, it is perhaps the easiest distortion figure to measure, which is presumably the reason for its common use. The apparatus (Fig. 2) consists of an oscillator with substantially less harmonic content than any equipment to be tested, a bridge or other device for balancing out the fundamental, and an amplifier and meter (theoretically r.m.s., but often not so in practice) for reading the distortion and comparing it with the total output. Such combinations are available commercially and can be used by unskilled persons.

When the distortion to be measured is of the 0.1% order, the requirement regarding purity of oscillator output is stringent, and filtration is likely to be needed; this in turn makes one anxious not to have to vary the frequency much. It is, of course, necessary to know the signal level or output power at which the distortion is read, and at a given level the distortion usually depends largely on the frequency. So unless the frequency also is stated, the significance of the reading is considerably reduced. If unmentioned, one would probably be safe in assuming it to be some middle frequency, such as 400 c/s or 1,000 c/s, and can only conjecture what it would be at 40 c/s!

"Weighted" Components

There is general agreement that the unpleasantness of a given percentage distortion, as measured in this way, depends to a very large extent on how that percentage is made up. If 1% total distortion consisted of 1% second harmonic and nothing else, it would sound very much better than if the first 13 harmonics were all present to the extent of 0.29% each (making the same total r.m.s. value). Therefore in the absence of further information the "total harmonic distortion"

is a very unreliable indicator of unpleasantness.

In order to bring the total harmonic reading more into line with aural impressions it was proposed as long ago as 1936⁶ that the higher harmonics should be "weighted" in direct proportion to the number of each harmonic, by multiplying the n th harmonic voltage by $n/2$. The percentage, weighted in this way, can be written

$$100 \sqrt{\frac{V_2^2 + (\frac{3}{2}V_3)^2 + (2V_4)^2 + \dots}{V_1^2 + V_2^2 + V_3^2 + V_4^2 + \dots}}$$

In 1950 D.E.L. Shorter⁷ produced evidence to show that this linear weighting is not drastic enough and that aural assessment is fitted more closely by a square law:

$$100 \sqrt{\frac{V_2^2 + (\frac{9}{4}V_3)^2 + (4V_4)^2 + \dots}{V_1^2 + V_2^2 + V_3^2 + V_4^2 + \dots}}$$

He admitted a practical difficulty, that high harmonics present in quantities insufficient to be accurately measured may nevertheless, when weighted thus, contribute significantly to the total.

On a basis of musical harmony theory, one would not expect the unpleasantness of harmonics to conform to any simple law. For instance, the 15th is less discordant than the 13th. But Shorter suggests that the fact that his weighting gives a figure related to the sharpness of curvature of the waveform may be significant. Some further research on this would be helpful.

Intermodulation Distortion

It is not difficult to guess why weighted systems have failed to achieve popularity. In the first place, though it be granted that they are a closer approach to our ideal, they seem somewhat arbitrary and thereby lacking in authority. Perhaps more decisively from a commercial viewpoint, they give figures higher than the unweighted total, and so there is what in official jargon would be called a strong disincentive to use them. It is rather surprising that no one has thought of advertising on a system in which the lower harmonics would be divided by an appropriate factor! Lastly, the apparatus is more complicated, though for simple proportional weighting not unduly so—details of a suitable instrument were given long ago⁶.

Although one rarely, if ever, sees a weighted distortion figure, the more highly technical specifications do occasionally reveal the separate percentages of the first few harmonics. Such figures can be derived from the output waveform or the transfer characteristics, but only with a good deal of effort and when the distortion is fairly large. For general purposes it is best to measure them individually with a wave analyser, of which more anon.

So now for harmonics; how about intermodulation? It is sometimes regarded as quite a different kind of distortion. There is certainly general agreement that the unpleasantness of non-linear sound reproduction is due more to intermodulation products than to harmonics.^{1, 8, 9} Therefore, some say, intermodulation is inherently a more reliable index to distortion than harmonics. But this does not necessarily follow, and if intermodulation is chosen it should be for some better reason.¹ For basically they are the same, and theoretically, given complete information about harmonic production, it is possible to calculate the intermodulation products, and vice versa.^{8, 10} Or given the

* But unless the distortion is more than about 10%, the denominator $\sqrt{V_1^2 + V_2^2 + V_3^2 + V_4^2 + \dots}$ can be replaced, with negligible error, by V_1 .

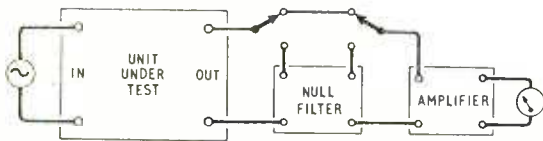

Fig. 2. Block diagram of the usual arrangement for measuring total harmonic distortion.

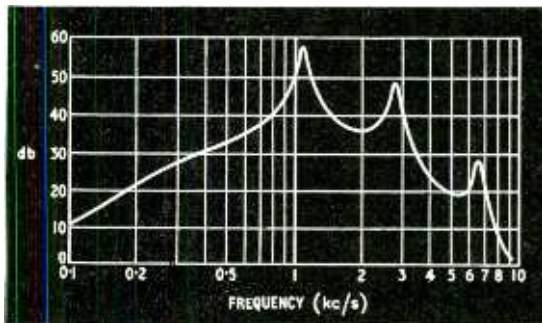

Fig. 3. Example of a frequency characteristic in which wide divergences between different methods of estimating distortion are to be expected.

non-linearity and input signal amplitudes, the amplitudes of both harmonics and intermodulation products follow, so that the ratio of one to the other is known.^{11, 12, 13} From this it seems reasonable to conclude that either should do almost equally well as a measure of distortion. On the other hand, however, many workers state that intermodulation data line up well with listening tests whereas harmonics do not.^{8, 14-20}

From these many references let us take two examples. The first is by H. E. Roys.¹⁵ He compared the total harmonics with total intermodulation resulting from the playing of disk records of test signals (400 c/s alone and 400 c/s with 4,000 c/s), using styli of specified point radius. He repeated the tests with "masters" (electroplated "negatives" of original engraved disks) that had been excessively polished, resulting in shallow flat-bottomed grooves in the pressings. These tests showed a great increase in audible distortion and in total intermodulation, whereas total harmonic readings were hardly affected. Roys concluded that whereas the intermodulation method of test corresponded with audible distortion, the harmonic test did not. And since he confined this conclusion to disk recording and reproducing, there seems to be no reason to question it. But it has been quoted by others¹⁷ as evidence that intermodulation can vary quite independently of harmonics in the circumstances generally assumed, viz., two or more signals being handled simultaneously by a non-linear unit, such as an amplifier or gramophone pick-up. The nature of Roys' experiment, however, was entirely different, involving intermediate mechanical processes not subject to the usual assumptions about non-linearity. On the information available, it seems likely that the polishing affected the 4,000 c/s ripple most at the peaks of the 400 c/s waves, which would result in 400 c/s modulation of the 4,000 c/s in the reproduction without necessarily causing much distortion of the 400 c/s reproduction. Roys' argument for preferring intermodulation tests, while justifiable for the particular chain of processes with which he was concerned, is

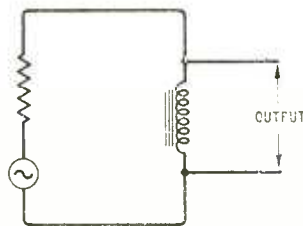

Fig. 4. A simple frequency-discriminating system, representing a typical output stage, in which the ratio of intermodulation to harmonic distortion is very different from that calculated for systems with level frequency characteristics.

quite invalid for non-linearity as generally understood.

The second example¹⁸ is one in which a particular form of intermodulation test on a deaf aid was found to correspond much better with aural tests than did the measurement of harmonic distortion. Examination of the distortion/frequency graphs obtained, however, shows that the frequency characteristic of the aid contained sharp peaks and deep hollows, and that these were responsible for the lack of proportionality between harmonic and intermodulation products. The strong indication of distortion by the preferred method of intermodulation measurement was due mainly to the frequency of the product measured, and a different kind of intermodulation method gave altogether different results. It is well that those of us whose distortion measurements are confined mainly to equipment with nearly flat frequency characteristics should be reminded that the simplifying assumptions that can be made for such equipment do not hold when the frequency characteristic is mountainous. Take for example the frequency characteristic shown in Fig. 3 and compare the distortion at 2 kc/s when measured as (a) the second harmonic, 4 kc/s, and (b) the difference frequency, 1.1 kc/s, between input signals at 2 kc/s and 3.1 kc/s. The amplification at 4 kc/s is more than 30 db down on that at 1.1 kc/s, so it is not surprising if method (b) gives a much higher reading under these conditions than method (a).

The moral is to refrain from applying to one set of conditions a conclusion established for quite a different set of conditions.

Influence of Frequency Response

The conditions for which a definite intermodulation/harmonic ratio (usually between 3 and 4) has been calculated^{11,13} are ideally simple: frequency characteristic perfectly level over a band embracing all the frequencies involved, and transfer characteristic conforming to a simple power series. Even so, the ratio depends on the number and coefficients of the terms in the series, and on the relative amplitudes of the test signals. The influence of frequency response

TABLE I

Order of Distortion	Harmonic		Intermodulation	
	Frequency	Percentage	Frequency	Percentage
3rd	180	8.0	520	3.3
5th	300	2.3	640	0.67
7th	420	1.7	760	0.67

is particularly important in connection with distortion caused by iron cores. To demonstrate this, the writer measured the distortion across an iron-cored inductor connected to a generator giving either one or two sinusoidal signals (Fig. 4). First the harmonics of a single 60-c/s signal were measured; then the intermodulation products caused by signals at 60 c/s and 400 c/s in the amplitude ratio 4:1 and having the same combined peak amplitude as the single signal. The results are given in Table I.

Here the intermodulation/harmonic ratio is fractional. The impedance of the coil was varying over the 60 c/s cycle, causing distortion of the waveform at that frequency. But at 400 c/s the impedance of the coil was much higher; consequently the 400 c/s was not modulated in proportion to the 60-c/s distortion.

It must be remembered, too, that if there is a non-linear element somewhere in the middle of the unit being tested, the signal amplitude ratio at the input of that element may differ considerably from the ratio at the input to the unit, and the distortion amplitude ratios at its output may differ considerably from those measured at the output of the unit, as a result of frequency distortion before or after the non-linear element.

Standard Intermodulation Test

Two methods of intermodulation measurement have been sufficiently used and recommended to have achieved some degree of standardization. In the first, sometimes called the S.M.P.E. method,^{8-11, 15, 20, 21} outlined in Fig. 5, the distortion is made to take place at a low frequency f_1 (say 100 c/s) and non-linearity is estimated by the extent to which a comparatively high frequency signal f_2 (say 1,000 or 4,000 c/s) of one quarter the voltage (12db down) is modulated by it. The distortion products occur at $f_2 \pm f_1$, $f_2 \pm 2f_1$, etc. If strictly carried out, the method indicates the total r.m.s. value of all these products, and so is analogous to "total harmonic distortion" measurement, for it makes no distinction between products of different order.* And because the kind of non-linearity that generates n th harmonic also generates intermodulation of the n th order, it is not surprising if, in general, the unpleasantness increases with the order of inter-

modulation¹⁴. There does not yet seem to be any conclusive evidence on the precise relationship, but the S.M.P.E. method is open to the same criticism as unweighted total harmonic measurement. It also possesses other possible causes of discrepancy¹², such as the characteristics of the output meter.

Following the same line of thought as with harmonics, one naturally inquires about weighting. The claim has been made that intermodulation measurement is self-weighting.^{17, 22} This can be investigated with the help of ref.¹³ We assume that a signal $v = V \cos \omega t$ is applied to an element having a single non-linear term kv^n and a level frequency characteristic. Column 2 in Table II shows the ratio of harmonic amplitude to fundamental V . It is interesting to note that this value applies whether $V \cos \omega t$ is the only signal present or not. If next the signal applied is $v = V_1 \cos \omega_1 t + V_2 \cos \omega_2 t$, column 3 shows the ratio of the coefficient of the n th order intermodulation product, $\cos(\omega_2 t - n\omega_1 t) + \cos(\omega_2 t + n\omega_1 t)$, to V_2 . The intermodulation/harmonic ratio is given in column 4. If V is identified as V_1 in the two-signal input, V_1/V goes out, and the ratios are as in column 5. Compared with the harmonics, the intermodulation products are weighted in direct proportion to their order, n . Since these ratios apply to both sum and difference products, they are multiplied by 2 in the S.M.P.E. method, which combines both.

The relative signal amplitudes just considered do not, however, present a fair comparison. A single signal used for harmonic distortion measurement should, to be comparable, have the same peak value as the double signal used for intermodulation. Column 6 therefore shows the ratios when $V = V_1 + V_2$. If, as in the S.M.P.E. method, $V_1 = 4V_2$ and the ratios are doubled, the results in column 7 show a weighting that begins feebly in the right direction and then reverses. The values for second and third order distortion agree with those calculated (and checked by experiment) in ref.¹¹ Distortion confined to the second order can be realized approximately in a single triode without negative feedback, and third-order distortion in a push-pull stage; but the other conditions (distortion of one order only, higher than the third) are artificial. In any case, fourth-order products are inevitably accompanied by much larger second-order products, fifth by third, sixth by fourth and second, and so on¹³; and these alter the ratios tabulated for second and third order, the tendency being to

* An intermodulation product of frequency $pf_1 \pm qf_2$, resulting from frequencies f_1 and f_2 , is said to be of the $p+q$ order (but some writers refer to it as the $p+q-1$ order).

TABLE II

1	2	3	4	5	6	7
Order of distortion, n	Relative harmonic amplitude	Relative intermod. amplitude	Intermod./harmonic ratio, R	R when $V = V_1$	R when $V = V_1 + V_2$	2R when $V = 5V_2$ $V_1 = 4V_2$
2	$\frac{kV}{2}$	$\frac{2kV_1}{2}$	$\frac{2V_1}{V}$	2	$2 / \left(\frac{V_2}{V_1} + 1 \right)$	3.20
3	$\frac{kV^2}{4}$	$\frac{3kV_1^2}{4}$	$3 \left(\frac{V_1}{V} \right)^2$	3	$3 / \left(\frac{V_2}{V_1} + 1 \right)^2$	3.84
4	$\frac{kV^3}{8}$	$\frac{4kV_1^3}{8}$	$4 \left(\frac{V_1}{V} \right)^3$	4	$4 / \left(\frac{V_2}{V_1} + 1 \right)^3$	4.08
5	$\frac{kV^4}{16}$	$\frac{5kV_1^4}{16}$	$5 \left(\frac{V_1}{V} \right)^4$	5	$5 / \left(\frac{V_2}{V_1} + 1 \right)^4$	4.08
6	$\frac{kV^5}{32}$	$\frac{6kV_1^5}{32}$	$6 \left(\frac{V_1}{V} \right)^5$	6	$6 / \left(\frac{V_2}{V_1} + 1 \right)^5$	3.92

Fig. 5. Block diagram of the usual arrangement (S.M.P.E.) for measuring total intermodulation.

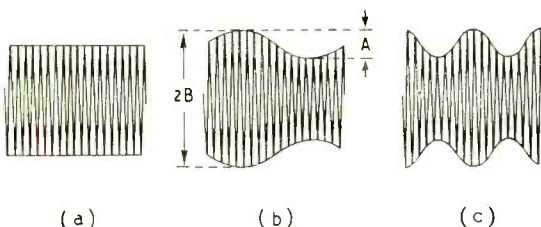
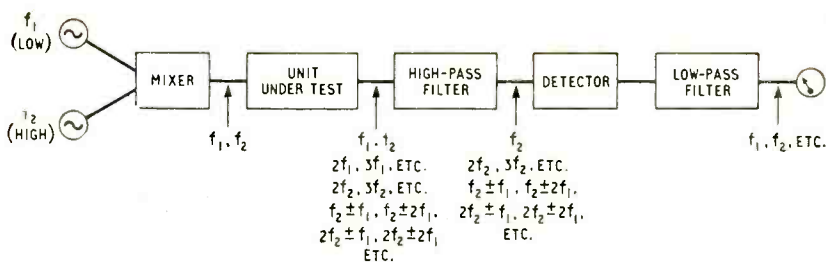

Fig. 6. Typical modulation envelopes showing (a) no distortion, (b) second-order distortion, (c) third-order distortion.

equalize the ratios. This is another fact that upsets the self-weighting theory.

Thus each different non-linear transfer characteristic has a different ratio of intermodulation to harmonics, and the ratio depends on whether the distortion products are measured separately or lumped together, but for practical non-linearities and no frequency discrimination it is fair to say that, as regards weighting, total intermodulation measurements show no advantage over harmonics. In fact, it is easy to see from Table II that if one uses signals of equal amplitude ($V_1 = V_2$) the weighting is the wrong way round!

The S.M.P.E. equipment has therefore been modified in various ways at the indicating end with a view to giving some degree of weighting to the higher-order products. In one variant¹⁶, called the peak-sum method, the indicator measures the peak value of the modulation-frequency output instead of the r.m.s. or the mean-rectified. When only one modulation frequency is present (because the distortion is all second or third order) all three values are of course in fixed proportion to one another, but in all other cases the modulation-frequency output is non-sinusoidal and its peak value is equal to the sum of the peak values of all the separate distortion components—provided that at some phase their peaks all coincide. Even if they always did (and it does not appear that this can be guaranteed) the result does not really amount to weighting, for the increase in reading due to the addition of any distortion component is quite independent of its order.

In another modification¹⁷, named after Le Bel but basically the same as that described much earlier by Bartlett²³, the indicator is a cathode-ray oscilloscope, which displays the modulated high-frequency signal without rectification, on a time base covering one cycle of the low-frequency signal, as in the usual c.r.o. method of measuring depth of modulation²⁴. When there is no distortion the trace has a rectangular envelope as in Fig. 6(a). Second and third order distortion produce patterns such as (b) and (c) respectively. Le Bel reckons the distortion by adding up the depths of all the "notches," such as A, in the pattern, counting both top and bottom. The sum of all the notch depths—two in (b) and four in (c)—is

divided by B and expressed in per cent. Third-order distortion therefore counts twice as much as second-order distortion causing the same depth of modulation. This seems to contradict a graph given with the original description of the method, connecting the notch-depth percentage with the unweighted S.M.P.E. intermodulation percentage, and stated to apply to amplifiers of all types. It should be noted that notch depth (A/B) is not the same as depth of modulation (which is $A/(2B-A)$) except at 100%; at low values it is nearly twice as great, not counting the additional doubling when the bottom notch is included. The weighting is a step in the right direction, but bears no simple relationship to the systems mentioned in connection with harmonics. Unless the c.r. tube is of a precision type and the pattern is carefully measured, the method is not suitable for testing modern low-distortion equipment.

Incidentally, the ratio of between 3 and 4 when measuring total intermodulation with a 4:1 signal ratio as in the S.M.P.E. method is sometimes quoted⁸ as ground for saying that such measurement is more sensitive than harmonic measurement. But it has been shown¹¹ that with some kinds of non-linearity the ratio may be as low as 1; and in any case the intermodulation percentage is reckoned with reference to a signal of only one fifth the amplitude that would be used for harmonic measurement, so this supposed advantage is illusory.

Another Standard Method

Quite different from the S.M.P.E. method is the C.C.I.F. method^{25, 18}. The input signals are equal in amplitude and differ in frequency by a constant frequency; it is the single distortion product at this difference frequency that is measured. The great advantage of this method is that distortion can be measured over the whole frequency band. On the other hand, only second-order distortion is measured. So, for example, a well-balanced push-pull amplifier would be made to appear almost distortionless, notwithstanding that it might have severe odd-order distortion, in which case one's ears would flatly contradict the instrument reading. The measuring instrument is preferably a wave analyser, which however need not operate at more than one or two fixed frequencies. Since neither of the two signals is stronger than the other, the frequency at which the distortion is being made to occur is ambiguous.

It is clear that (notwithstanding suggestions to the contrary) no one of all these many methods of measuring non-linearity distortion can be relied upon to give readings in agreement with listening tests, unless some restrictions are placed on the nature of the items tested. For testing iron-core transformers, Williams and Eastop²⁶ prefer harmonic measurements to intermodulation, because there are fewer variables and

correlation is as good; for film and disk recording, the S.M.P.E. intermodulation method has become firmly established^{10, 15, 21}; for hearing aids both these methods are regarded as useless and the C.C.I.F. method strongly advocated¹⁰.

Suitability of Methods

What do we conclude from all this? Surely that the method or methods chosen must be those that experience has shown to agree with aural judgment, over the whole range of equipment to be tested and the whole range of distortion liable to occur in it. Thus, for routine tests of similar units in which the kind of distortion is unlikely to vary and one only wants to check that the amount is tolerable at a specified level, quite a simple total harmonic or intermodulation system may do. If the kind of distortion is liable to vary, then a weighted system would be preferable. An advantage of a total system is that it can be applied where (as sometimes in reproduction from records) the frequency is not constant enough for wave-analyser readings. On the other hand, during development of new equipment, in which every possible kind of distortion must be investigated before final approval—and especially where different kinds of equipment are developed—it is necessary to have apparatus capable of separately measuring all the distortion components under any desired conditions; in other words, at least a generator producing two signals variable over the full frequency range, and a wave analyser. Such equipment is somewhat expensive, but it is proposed to describe in a future issue apparatus capable of a wide range of reasonably accurate measurements and of being constructed at moderate cost.

For investigating distortion at low frequencies, the choice lies between measuring the harmonics of a single signal at that frequency or the modulation by it of a relatively high-frequency low-amplitude signal. As regards the signal generator, the advantage of needing only one signal for harmonics must be considered against the advantage of needing less extremely pure waveform in the two required for modulation. As regards output-measuring equipment, if total unweighted values are required the balance between harmonics and intermodulation is perhaps fairly even. But a weighted total reading is more easily obtained for harmonics. Separate measurement of each order of distortion necessitates a more selective wave analyser for modulation than for harmonics, but the frequency characteristic of the unit under test is less likely to affect the relative amplitudes, and the distortion measured can be at more audible frequencies.

At high frequencies, neither system yields a series of distortion products, corresponding to the different orders, within the a.f. band. But if there is second-order distortion, beating between upper frequencies is audibly objectionable, and this is where the C.C.I.F. method (or something like it) is valuable. In recording and f.m. systems, the amplitude of the high frequencies is increased by pre-emphasis, and any overloading at these frequencies yields distortion products at lower frequencies, which are not reduced by the subsequent de-emphasis so become relatively more prominent.

At medium frequencies no particular method is always the best, and choice depends on circumstances.

While the need for versatility and flexibility thus seems to exclude all hope of standardization, there ought not to be a greater variety of test conditions

than is really necessary. The writer would like to suggest that, except where special circumstances indicate otherwise, a fixed distortion-product frequency somewhere in the most audible part of the band (say 1,000-2,000 c/s) should be adopted. A fixed frequency simplifies apparatus and operation, and removes one of the biggest sources of disagreement between meter readings and aural appraisal—their widely dissimilar frequency characteristics. Choice of a middle frequency ensures that what is read is actually highly audible distortion, even though it may be generated by tones of relatively low audibility.

For example, suppose the chosen frequency is 1,320 c/s (this rather odd choice was to minimize the risk of spurious responses). Then Table III shows typical (but not necessarily the best possible) input frequencies for measuring the distortion at representative points in the a.f. band. Adoption of the widely used 4:1 amplitude ratio is recommended, because it leads to distortion that is predominantly at the frequency of the stronger signal, and does not discriminate against the higher orders like equal signals.

Although he may in that respect be unfashionable, the writer refrains from making the claim that the scheme he recommends gives complete correlation between measurements and audible distortion, but does suggest that it may be less liable to be “caught out” by particular circumstances than some for which such claims have been made.

Perhaps the most instructive form in which the results of measurements according to such a scheme can be presented is as graphs (one for each strong-signal frequency) showing as separate curves the variation of each distortion product with output power. There is some evidence¹⁴ that the point where odd-order intermodulation starts a rapid rise corresponds to the onset of audible distortion. Whether this generalization is valid or not, it is important that any distortion data should bring out two things: (1) Whether the distortion is mainly second or third, and (2) Whether the series converges rapidly (so that products above the third are negligible) or slowly (so that there are appreciable quantities of the higher orders, indicating some sharp curvature in the transfer characteristic).

In equipment in the high fidelity class, products higher than the third ought to be negligible, so particulars of distortion in its specification would normally be much less formidable than Table III might suggest. Along with the assurance that all higher-order modulation is less than 0.2% it should

TABLE III

Order of modulation product	Frequency of weak signal when strong signal frequency is:			
	65 c/s	800 c/s	3,000 c/s	12,000 c/s
1 (fundmtl.)	1,320	1,320	1,320	1,320
2	1,385	2,120	4,320	13,320 (or (10,680))
3	1,450	2,920	7,320	
4	1,515	3,720	10,320	
5	1,580	4,520	13,320	
6	1,645	5,320	16,320	
7	1,710	6,120	19,320	

be sufficient to give the percentages of second and third at two suitable frequencies. Some substantial improvement on present practice need not therefore be completely unpractical.

REFERENCES

¹ "Cathode Ray," "Distortion" and "More Distortion," *Wireless World*, April, May, 1955, p. 191, p. 239.
² Tyler, V. J., "Simple distortion meter," *Wireless World*, Sept. 1953, p. 431.
³ Wigan, E. R., "Diagnosis of distortion," *Wireless World*, June 1953, p. 261. See also ⁴.
⁴ Pressey, D. C., "Measuring non-linearity," *Wireless World*, Feb. 1954, p. 60.
⁵ B.S.2065: 1954. *Glossary of Terms for Characteristics of Radio Receivers*, Defn. 319.
⁶ Radio Manufacturers' Association, "Specification for testing and expressing overall performance of radio receivers," 1936. (Reproduced in *Proc. Wireless Section I.E.E.*, Sept. 1937, p. 12).
⁷ Shorter, D. E. L., "The influence of high-order products in non-linear distortion," *Electronic Engineering*, April 1950, p. 152, and correspondence Oct. 1950, p. 443 and July 1951, p. 278.
⁸ Hilliard, J. K., "Distortion tests by the intermodulation method," *Proc. I.R.E.*, Dec. 1941, p. 614, and discussion, Sept. 1942, p. 429.
⁹ Roddam, T., "Intermodulation distortion," *Wireless World*, April 1950, p. 122.
¹⁰ Frayne, J. G., and R. R. Scoville, "Variable density recording," *J. Soc. Motion Pic. Eng.*, June 1939, p. 648.
¹¹ Warren, W. J., and W. R. Hewlett, "An analysis

of the intermodulation method of distortion measurement," *Proc. I.R.E.*, April 1948, p. 457.
¹² Berth-Jones, E. W., "Intermodulation Testing," *Wireless World*, June 1951, p. 233.
¹³ Callendar, M. V., and S. Matthews, "Relation between amplitudes of harmonics and intermodulation frequencies," *Electronic Engineering*, June 1951, p. 230.
¹⁴ Harries, J. H. O., "Amplitude distortion," *Wireless Engineer*, Feb. 1937, p. 63.
¹⁵ Roys, H. E., "Intermodulation distortion analysis as applied to disk recording and reproducing equipment," *Proc. I.R.E.*, Oct. 1947, p. 1,149.
¹⁶ Fine, R. S., "An intermodulation analyzer for audio systems," *Audio Engineering*, July 1950, p. 11.
¹⁷ Le Bel, C. J., "A new method of measuring and analyzing intermodulation," *Audio Engineering*, July 1951, p. 18.
¹⁸ Peterson, A. P. G., "Intermodulation distortion," *General Radio Experimenter*, March 1951, p. 1.
¹⁹ Scott, H. H., "Intermodulation measurements," *J. Audio Eng. Soc.*, Jan. 1953, p. 56.
²⁰ Hilliard, J. K., "Intermodulation testing," *Electronics*, July 1946, p. 123.
²¹ Read, G. W., and R. R. Scoville, "An improved intermodulation measuring system," *J. Soc. Motion Picture Engineers*, Feb. 1948, p. 162.
²² Sturley, *Radio Receiver Design*, 1st edn., Part 2, p. 82.
²³ Bartlett, A. C., "Inter-modulation in audio-frequency amplifiers," *Wireless Engineer*, Feb. 1935, p. 70.
²⁴ Van Beuren, J. M., "Simplified intermodulation measurements," *Audio Engineering*, Nov. 1950, p. 24.
²⁵ *Proc. C.C.I.F.*, 1936, p. 684.
²⁶ Williams, T., and R. H. Eastop, "Harmonic distortion in iron-core transformers," *Audio Eng.* April 1951, p. 18.

LETTERS TO THE EDITOR

The Editor does not necessarily endorse the opinions expressed by his correspondents

Transistor Letter Symbols

FURTHER to D. Nappin's letter (your May issue) on this subject, the inter-service symbol for a switch has for some years been the letters SW. Recently, however, this has been modified by BS530 (Supplement No. 1 amended) which lists "mandatory designations" and "designations normally used" in Tables 1 and 2 respectively. The latter table lists the letter S for a switch.

I, personally, favour the suggestion put forward by Mr. Thompson (in the same issue). The letter Y is so far not in use in the Tables referred to above, and the similarity to the circuit symbol is a very good argument for its adoption.

Signals Research and Development Establishment. K. J. NEIGHBOUR.

SINCE the thermionic tube was given the name of "valve" because it would not permit a reverse flow of electrons, and since a transistor, properly used, has the same characteristic, it seems to have the same claim as the former to the word "valve" and hence to the symbol V. The Americans, of course, have no problem. For them tubes, with a T, are being replaced by transistors, also with a T. No doubt those amongst us whose valves have "plates" fed from "rails" and control grids apparently made of corrugated iron will follow in this also.
 College of Technology, Manchester. V. MAYES.

F.M. Receiver Design

I AM surprised that M. R. Murray in his contribution on the ratio detector on page 245 of your May, 1955, number made no reference to an article on f.m. reception by D. Maurice and R. J. H. Slaughter in the March, 1948, issue of *Wireless World* (page 103).

This latter article gives a convincing but simple explanation

of the suppression of unwanted amplitude modulation. I am afraid Mr. Murray did not convince me that his unbalanced circuit was capable of the necessary suppression. The statement is made that the a.f. output follows the ratio $V_{K'd}/V_{a''a}$. This statement is not substantiated nor are its consequences followed up.

I disagree with his statement that with a suitably designed circuit the ratio $V_{K'd}/V_{a''a}$ follows faithfully the original audio modulation. This is only true when second and higher orders of small quantities are neglected.
 Malvern, Worcs. F. L. MORRIS.

I FAIL to understand why Messrs. Amos and Johnson should choose the ratio detector for their f.m. receiver. While saving a valve may be of prime importance to a set maker, it should surely not be decisive to the home constructor. It seems illogical to save a valve at the cost of trebling the distortion (on the figures quoted in the article) and feed the output, as most will be doing, into a high-quality amplifier in which no expense has been spared to get the distortion down to the 0.1% level. Or is there some mystic reason why 3% in the detector does not matter, but 3% in the output stage does (perhaps "Cathode Ray" can enlighten us?). Incidentally, what has happened to Thomas Roddam's circuit²? Does it really work?
 Redhill, Surrey. J. K. CARTER.

Proprietorship of Band III

ON May 11 it was announced that the B.B.C. have ordered transmitting equipment to enable them to start a second television programme on wavelengths in Band III.

Declaring my interest in one of the programme contractor companies (Associated-Rediffusion, Ltd.), I wrote

¹ Amos & Johnstone; *Wireless World*, April 1955.
² Roddam; *Wireless World*, July 1948.

a letter to *The Times* (printed May 13) to protest against any attempt by the B.B.C. to take Band III channels.

It is generally accepted that the five Band I channels which the B.B.C. already use can cover an area at least equal to that which the eight Band III channels can cover when Band III is completely cleared for television purposes. On these grounds, the entire Band III will be required to take the I.T.A. programmes to the whole country in a similar manner as all of Band I is required to take the B.B.C. programme to the whole country.

It might, of course, be argued that it would be better to have an entirely new deal and that both Band I and Band III should be shared by the B.B.C. and I.T.A.

It may be thought by some that Band I channels should be used for such large integral areas as London, the Midlands and parts of the North of England for both B.B.C. and I.T.A. transmissions and that technically it would be better for Band III channels to be used for the smaller areas.

On this basis a complete re-examination of Band I and Band III allocations may be desirable. However, in view of all the factors concerned and specially the dislocation that would be caused to existing television installations, on balance it may be best to leave the B.B.C. with the five Band I channels, in which case the I.T.A. are certainly entitled to all the eight channels in Band III.

It is quite feasible that the B.B.C. and I.T.A. should plan second programmes but surely the proper frequency allocations for such second programmes should come, in the case of the B.B.C., from any spare facilities they may have available in Band I, and similarly, in the case of the I.T.A., any spare channel they may find in Band III. If, as is very likely, neither the B.B.C. nor the I.T.A. can find sufficient spare channels in Band I and Band III respectively to provide their respective second programmes over the major part of the United Kingdom, then both the B.B.C. and the I.T.A. must look to Band IV for the augmentation of their second programme services.

The I.T.A. are having many obstacles put in their way and have to overcome public resistance to the expense of converting sets to Band III reception. The I.T.A. and its programme contractors are quite prepared to meet these obstacles and are fully confident they will overcome them. It is hoped that the B.B.C. will not be frightened of meeting a similar challenge, possibly shared with the I.T.A., in opening up Band IV for second programmes.

Associated-Rediffusion, Ltd. PAUL ADORIAN.

“F.M. Tuning Indicator”

IT SHOULD be pointed out that although the indicator described in the June issue displays ingenious circuitry it passes grid current back through the ratio detector. This is undesirable and places the device out of court.

To align a discriminator it is usual to use a centre-reading valve voltmeter, a simplified version of which is all that is required as a tuning indicator. Using a single valve, sufficiently biased to stop grid current and a meter movement as an indicator, it is very easy to arrange a suitable circuit. Nothing more elaborate is needed.

Hayes, Middx. C. H. BANKS.

The author of “F.M. Tuning Indicator” writes:—

I am grateful to Mr. Banks for his comments, although I cannot help feeling he is being a little hasty in so summarily putting the device out of court.

The grid current which flows is quite negligible, being limited by the 2-M Ω resistor R1. In practice, connecting the indicator to a working ratio discriminator circuit causes no measurable change in its characteristic whatsoever, even when the audio take-off point has a positive voltage of some 10 volts or so. The latter state of affairs would, of course, occur only if the associated receiver were badly off-tune.

The simple unbalanced single-valve indicator described by Mr. Banks would only be attractive when high voltage swings were available at the audio take-off point and the

error introduced would be proportionately small. This is due to the drift inherent in such a circuit, especially when unregulated power supplies are employed.

J. R. DAVIES.

“As She Is Spoke”

E. L. E. PAWLEY'S letter (March issue) on the B.B.C.'s use of terms relating to words and recordings does not explain the meaning of the mysterious announcement often made at the end of a broadcast of music or of a play, namely, the announcement that “the performance was recorded.”

In plain English this means that a record (for future reproduction) was made of the performance while it was being broadcast. Is this what the announcement is intended to mean in B.B.C. English? Or is it intended to mean that the performance was not actually a performance at all, but was what the B.B.C. calls “a broadcast from a pre-recording”?

Incidentally, is not the B.B.C.'s use of the term “a broadcast from a pre-recording,” and its attempt to distinguish this from the playing of a record, an example of confusion of thought? A “broadcast from a pre-recording” is nothing but the playing of a record. There can be no pre-recording of a performance; there is only a recording or only a record of a past performance. The length of time that elapses between the recording of the past performance and the playing of the record is quite irrelevant to the nature of the broadcast.

It seems that the real distinction that underlies the curious terminological distinction drawn by the B.B.C. is merely the distinction between the playing of a record made by a gramophone company and the playing of a record that they have made themselves.

Osterley, Middx.

R. H. NISBET.

“Needles for Talking Machines”

I AM grateful for “Free-Grid's” addendum (June, p. 302) to my article in the May issue. My beard is at present only very slightly flecked with grey and the year 1910 is extremely dim in my memory. It will not therefore be necessary for “Free-Grid” to continue collecting steel gramophone needles for his bed, as my statement on steel needle production at a rate of 6½ million per day in 1911 is indicative of an extremely large production, which obviously could not have grown up overnight. I had always understood that except for long-haired grey beards, the cylinder-type machine “died” before the First World War, and I wonder if the Gamage's machine at 3s 6d could not possibly have been a job-lot for the inveterate bargain-hunter.

Apropos of there “being nothing new under the sun,” I received a letter containing a sample of pure beryllium from Mr. H. J. Leak, who states that whilst foil 0.005in thick is available it is impossible to work the material satisfactorily in its present state because of its highly crystalline nature; entirely apart from a prohibitive cost of £3 per square inch. I am concurrently investigating the production of stylus arms from pure beryllium by pressing a powdered aggregate to the final shape and then sintering at a fairly high temperature. This method is being successfully applied to a number of similar materials such as tungsten carbide, ferrites, etc.

Kelly Acoustics, Ltd., London, N.3. S. KELLY.

CORRECTIONS

IN referring to the **Solartron square-wave generator**, Type G0511, on page 276 of the June issue, the output waveform rise and fall times were given in microseconds; they should have been in milli-microseconds.

Miniature Transistor Hearing Aid. The gain of the Multitone “Minuet” described on page 290 of the previous issue is 70db, and not 20db as stated.

Spurious Radiation from Wrotham

A Problem in Co-sited Transmitters

By J. R. BRINKLEY*

A RECENT issue of *Wireless World* contained an article¹ on yet another radio controversy, namely "to co-site or not to co-site." It described some of the advantages and disadvantages of arranging I.T.A. television stations to be on, or near, existing B.B.C. television sites. As one of a number, and I think quite a large number, who suffer in the fringe of all B.B.C. services, existing and planned, I am indulging in a purely selfish hope that the I.T.A. will pick entirely different sites so that perchance someone else may have my I.T.A. fringe.

It would seem to me that there are some arguments in favour of co-siting stations in the same band, but a rigid policy of co-siting Band I and Band III transmitters would be unwise; to co-site these with Band IV and V stations would be ridiculous.

The subject of this article is, however, to draw attention to a somewhat different problem which has arisen as a result of carrying co-siting to the ultimate limit in the B.B.C. v.h.f. station at Wrotham. The high-power transmitters for the Home, Light and Third programmes at Wrotham are not only co-sited but share the same building and mast. Furthermore, all three transmitters are actually fed into the same aerial. The frequency separation between the programmes is approximately 2% of the carrier frequencies employed and since the design of filters to separate the three high-power carriers so closely spaced is necessarily a difficult proposition it is not surprising that interaction between transmitters is in evidence. The design of the aerial used has been described elsewhere.^{2, 3}

That transmitters which have any mutual coupling and are closely spaced in frequency can combine to produce spurious products is well known.⁴ The phenomenon is due to the fact that each transmitter output stage as "seen" by the others is a non-linear device in which the separate carriers mix and produce new and unwanted components. At large transmitting sites, such as the G.P.O. station at Rugby and the B.B.C. station at Daventry where many transmitters operate, the phenomenon is well known. Such non-linearity can also occur on masts and stay wires, especially if these are rusty, and the noise and inter-

* Pye Telecommunications, Ltd.

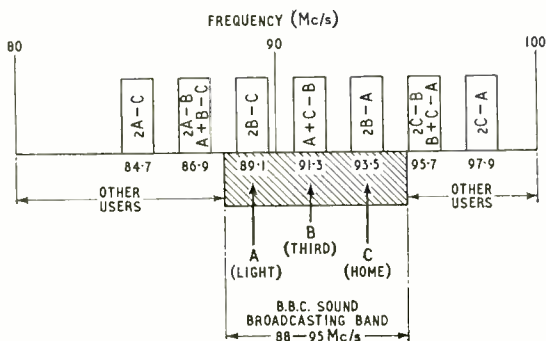

Third-order intermodulation products radiated from Wrotham.

modulation experienced from this cause when operating several v.h.f. sets simultaneously aboard warships became known as "rusty bolt effect."⁴

The coupling taking place at Wrotham is, however, stable and appears to be due to direct coupling between the transmitters. The worst products are, of course, the third-order products which take the well-known forms 2A-B, etc., and A+B-C, etc. The Figure shows the disposition of the third-order products relative to the carriers. The attenuation achieved in the band-stop filters is such that the level of these components is about 65db below the carrier. This is a high degree of attenuation and eliminates audible cross-talk between transmitters, but unfortunately it still permits a high level of interference radiation. Thus third-order products have been measured at Hampstead (28 miles from Wrotham), Brentford (23 miles from Wrotham) and Danbury (31 miles from Wrotham) and they have been found to have field strengths of the order of 5 microvolts per metre. This will, of course, cause widespread interference to services on the frequencies concerned.

The interference has the curious and sometimes amusing characteristic of carrying the modulation of two or three of the programmes simultaneously. Since the deviations add, the total peak deviation is $\pm 225\text{kc/s}$ and the total sideband spread approximately $\pm 300\text{kc/s}$. The overall effect of this is to render much valuable ether space unusable for the services for which it was intended. When it is remembered that multiple transmitter stations similar to Wrotham are planned in the vicinity of all populous centres throughout the country and that higher-order products also occur it will be seen that the matter is one of great importance and that this kind of interference must be eliminated.

In conclusion it must be emphasized that these spurious intermodulation products are unlike the normal harmonic radiation which takes place from high-power transmitters. They are different in three respects. First they occupy much more frequency space. Secondly, since they are close to the wanted carrier they are more difficult to filter. The third and most important difference is that they are *completely avoidable*. It is only necessary to employ separate aeriels suitably spaced to avoid significant mutual coupling virtually to eliminate these troublesome components completely. Whether this can be done on a single mast or whether separate masts will be necessary is a matter for investigation but most assuredly the solution must be established before further stations are commissioned.

REFERENCES

- ¹ "I.T.A. Transmitters" *Wireless World*, March, 1955, p. 120.
- ² "Wrotham Aerial System," by C. Gillam. *Wireless World*, June/July, 1951, p.p. 210-214, 279-282.
- ³ "Wide Band Folded-Slot Aeriels," by G. D. Monteath. *Journal I.E.E.*, Vol. 97, Pt. III, 1950, p. 414.
- ⁴ "External Cross-Modulation in the 100 mc/s Band," by K. W. Blake. *Journal I.E.E.*, Vol. 94, Pt. IIIa, 1947, p. 659-662.



Design for a

By D. H. W. BUSBY

THE circuit described in this article was designed primarily for use with the 20-watt high-quality amplifier described in last month's issue of this journal*. The pre-amplifier requires a line voltage of 250 V at 3.0 mA and may be used with high-quality amplifiers requiring not more than 200-250 mV input, at high impedance, for full rated output. The circuit employs three Mullard EF86 high-gain low-hum pentodes and offers a maximum pickup sensitivity of 3.5-4 mV for 200 mV output. Provision is made for continuously variable tone control, playback equalization and high- and low-pass filtering.

Performance.—An output of approximately 200 mV from the pre-amplifier will fully load the 20-watt amplifier to its rated output.

The total harmonic distortion at 400 c/s on any switch position for 200 mV output is not more than 0.1%. Since the gain control is at the output of the pre-amplifier the overload characteristic is the overall figure for the whole pre-amplifier, and at 20-db overload, i.e., for an output voltage of approximately 2 V, the total harmonic distortion for any switch position is not more than 0.2%.

Intermodulation distortion was measured by the S.M.P.T.E.† method at 40 c/s and 10 kc/s through the combination of the pre-amplifier and the power amplifier, due to the difficulties encountered when making such critical measurements at low levels on the pre-amplifier alone. With the gain control fully advanced and 20 watts equivalent sine-wave power output the intermodulation distortion was not more than 1%. With 20 db overload in the pre-amplifier, and the gain control set for 20 db attenuation in order to produce 20 watts equivalent sine-wave power output, the intermodulation distortion was not more than 3%. The intermodulation of the power amplifier alone at this level was found to be 0.7%. When measurements are made on positions which involve playback equalization it is necessary to weight incoming signals, due to the differing sensitivities at 40 c/s and 10 kc/s, to obtain the correct ratio through the pre-amplifier.

Background noise was measured on all switch positions and input sockets under practical conditions, which are stated in the summary of performance, and is referred to the nominal input sensitivity, since this is the most general way of stating the signal-to-background ratio. Since the gain control is at the output

Fig. 1. Complete circuit diagram of pre-amplifier.

* Mullard Valve Measurement and Application Laboratory.
 † Society of Motion Picture and Television Engineers. See also "Electronic Measurements" by Terman and Pettit (McGraw Hill).

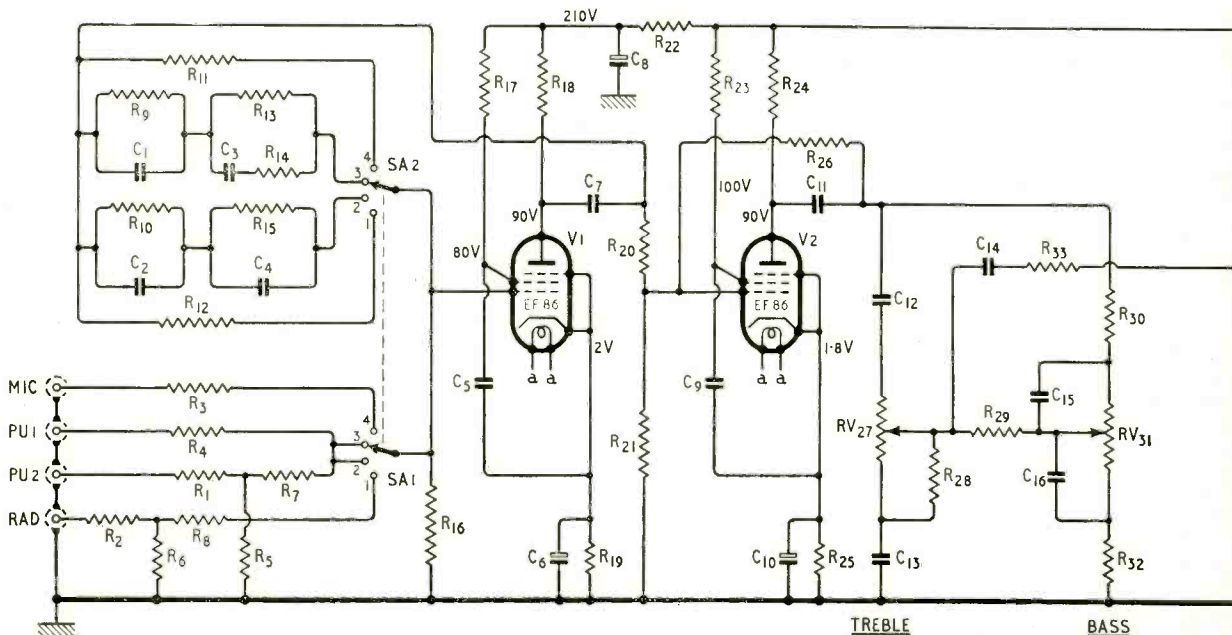

Pre-Amplifier

For Use with a 20-watt High-quality Amplifier

of the pre-amplifier it follows that the stated signal-to-background ratio will be maintained at all settings of the gain control.

Layout.— Considerable thought has been given to layout, since many difficulties may be encountered when working at such high sensitivity, and the proposed layout was found to be very suitable from all considerations. In general with pre-amplifier circuits it is essential to adhere closely to the suggested layout if the published performance is to be obtained in practice. The components and sections of the pre-amplifier have been arranged in logical sequence as far as is compatible with satisfactory performance.

In order to obtain the required line voltage of 250 V in conjunction with the 20-watt power amplifier¹, it is necessary to arrange that a 56-k Ω resistor, decoupled by at least 8 μ F, is introduced to drop the available voltage (410 V) at the power amplifier.

Input Stage.— Four input sockets are provided, one for radio and equalized tape, two for pickups and one for microphone, the basic sensitivity for each position

being arranged by anode-to-grid feedback. The input is selected by switch SA1. The basic sensitivity of the pickup input is employed to make it possible to use pickups of sensitivities 3-6 mV on socket PU1 and suitable attenuation is introduced to facilitate the use of magnetic pickups and good-quality crystal pickups on socket PU2.

The crystal pickup must be loaded suitably for output proportional to stylus velocity. By using a large proportion of the full gain of the first stage a microphone input sensitivity of 1.5 mV is obtained. The sensitivity for radio/tape input is basically 30 mV but has been attenuated to 100 mV in the circuit.

V2 and Tone Control.— V2 in Fig. 1 is employed as a convenient method of obtaining sufficient amplification to overcome the loss of the passive tone control which is included in the circuit. At the same time the use of anode-to-grid feedback offers a comparatively low source impedance and therefore has little or no effect on the tone control stage. The resistor R₂₀ in the grid of V2 minimizes interaction between this stage and the input stage

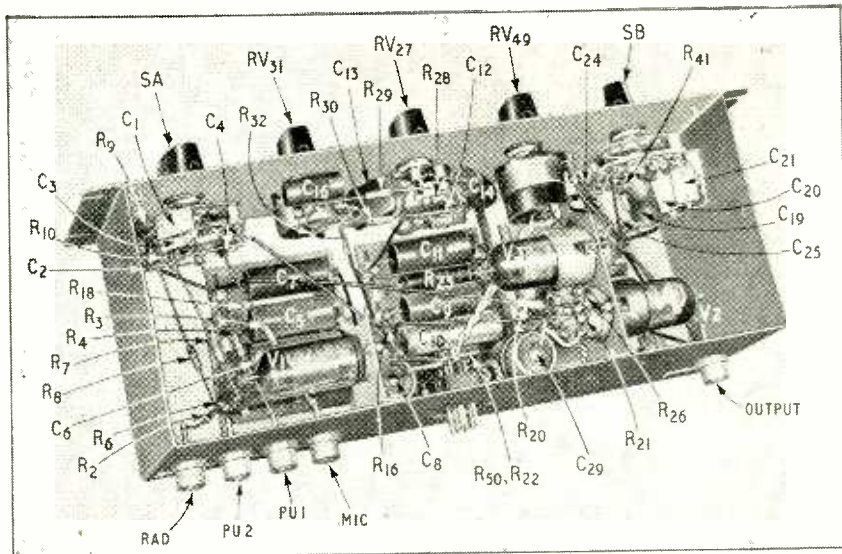

Underside of chassis showing positions of most of the components.

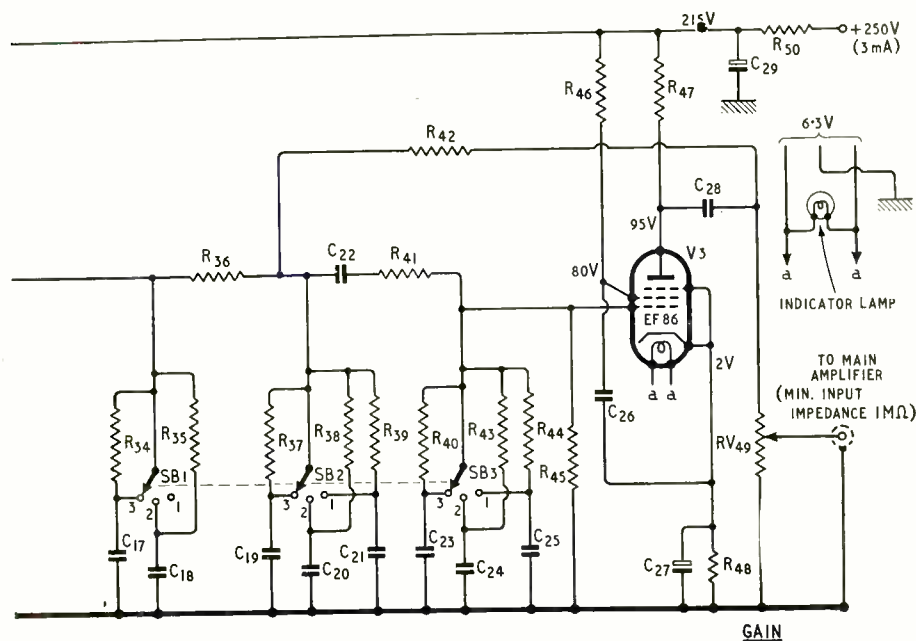

due to the inherent variation of impedance with anode-to-grid feedback.

The tone control stage was designed specifically to employ potentiometers which follow a logarithmic law, with 10% of maximum resistance at 50% rotation. It will be found convenient in practice to arrange that each potentiometer has a resistance, between slider and the earthy end, of 25 kΩ when the indication knob is at 50% rotation. Provided all the components of the stage are within the stated tolerances the "flat" position should be obtained very close to the 50% rotation position of the bass and treble controls. The curves in Fig. 2 show the tone control characteristics with the filter at Position 3, the "flat" position. The curves include the action of the high-pass filter.

Filters and V3.—When considering the choice of frequencies to be employed for low-pass filtering it was thought that a minimum number should be employed to preserve a certain measure of simplicity, whilst still maintaining a useful choice. Position 3 of switch SB is known as the "flat" position and limits the frequency response above 20 kc/s. Peak amplitude components beyond 20 kc/s are frequently contained in the output of wide-range pickups and may be greater than these below 20 kc/s. These inaudible components can introduce distortion or unnecessary limiting of available output power. Position 2 attenuates frequencies above 10 kc/s and is envisaged as being useful to curtail the effects of high-frequency distortion due to the input signal. Crystal pickups do not extend in frequency response much above 10 kc/s and at present the f.m. transmissions are not in general modulated above 10 kc/s; consequently this position may also be used to advantage under these conditions. Position 1 attenuates frequencies above 5 kc/s and is not intended for use with microgroove records but is intended to enhance reproduction of standard shellac records with inherently high-surface noise. By the use of R-C

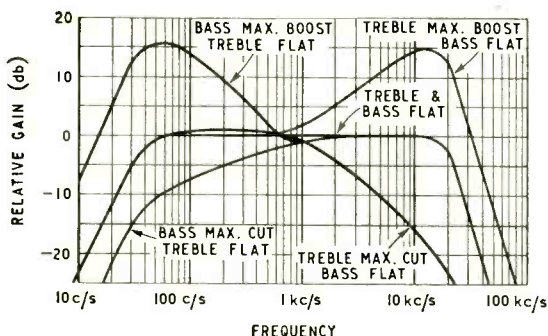

Fig. 2. Tone control frequency response characteristics.

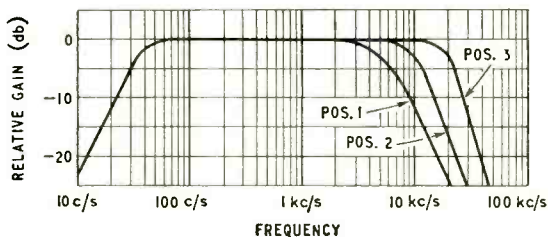

Fig. 3. Response with high-pass and low-pass filters.

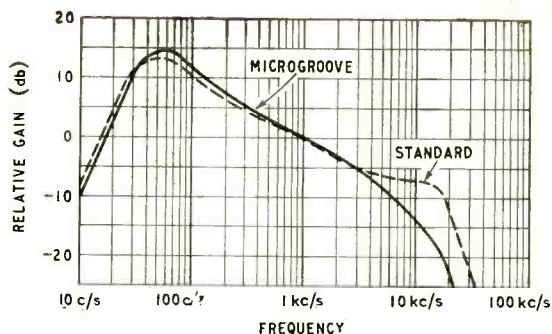

Fig. 4. Record playback characteristics adopted in the pre-amplifier.

filtering and feedback² an attenuation is obtained at these frequencies of not less than 12 db/octave. A high-pass, or rumble, filter has been introduced into this stage to attenuate frequencies below 35 c/s, at a slope of not less than 12 db/octave, in order to obviate the possibility of sub-audio frequencies overloading the system, and to cut motor rumble.

Output.—The 100-kΩ logarithmic gain control is an integral part of the output stage, since it is part of the feedback arm, and since the output it taken from this point it is of comparatively low impedance. The output of the pre-amplifier, however, should not look into an impedance less than 1 MΩ. It was found, in fact, that a capacitance of 400 pF could be placed across the output, with the gain control fully advanced, with negligible loss of output at 15 kc/s. This means in practice, for instance, 20 ft of co-axial cable of capacitance 20 pF/ft.

Playback Equalization.—Consideration of the utility of providing a number of playback characteristics resulted in a decision to use only one characteristic for microgroove and one for standard records. This departure from conventional design was decided not only from the point of view of a considerable saving in components but also from the fact that the majority of record manufacturers are recording nominally to the R.I.A.A.³ characteristic for microgroove recordings, and those remaining are sufficiently close to make it possible to compensate for the difference by judicious use of the wide-range tone controls available. The microgroove playback characteristic employed in this circuit is based upon the R.I.A.A. playback curve, but below 1 kc/s is slightly different to the extent of providing closer approach to a mean curve encompassing earlier recording characteristics. The standard playback characteristic is based upon the suggested E.M.I. playback characteristic,⁴ but is modified above 1 kc/s to provide additional cut to offset slightly the inherently higher noise level of standard recordings.

Acknowledgment.—The author wishes to express his thanks to Mr. W. A. Ferguson for his assistance in designing the pre-amplifier and for his constructive criticism in the preparation of this article.

REFERENCES

- ¹ "Design for 20-watt High-Quality Amplifier," by W. A. Ferguson, *Wireless World*, June, 1955.
- ² Gramophone and Microphone Pre-amplifier, by P. J. Baxandall, *Wireless World*, January, 1955.
- ³ Record Industry Association of America, Inc., "Radio Electronics," May, 1954, p. 63.
- ⁴ "The Pursuit of High Fidelity," booklet by E.M.I., Ltd.

PRE-AMPLIFIER UNIT—LIST OF COMPONENT VALUES

Resistors

R ₁	82kΩ	10%	0.25W	R ₁₈	270kΩ*	10%	1W	R ₃₄	10MΩ	20%	0.25W
R ₂	68kΩ	10%	0.25W	R ₁₉	3.9kΩ*	10%	1W	R ₃₅	10MΩ	20%	0.25W
R ₃	680kΩ	10%	0.25W	R ₂₀	220kΩ	10%	0.25W	R ₃₆	68kΩ	5%	0.25W
R ₄	82kΩ	10%	0.25W	R ₂₁	470kΩ	10%	0.25W	R ₃₇	10MΩ	20%	0.25W
R ₅	8.2kΩ	10%	0.25W	R ₂₂	18kΩ	10%	0.25W	R ₃₈	10MΩ	20%	0.25W
R ₆	27kΩ	10%	0.25W	R ₂₃	470kΩ*	10%	1W	R ₃₉	10MΩ	20%	0.25W
R ₇	82kΩ	10%	0.25W	R ₂₄	100kΩ*	10%	1W	R ₄₀	10MΩ	20%	0.25W
R ₈	100kΩ	10%	0.25W	R ₂₅	1.2kΩ*	10%	1W	R ₄₁	47kΩ	5%	0.25W
R ₉	5.6MΩ	5%	0.25W	R ₂₆	8.2MΩ	10%	0.25W	R ₄₂	820kΩ	5%	0.25W
R ₁₀	6.8MΩ	5%	0.25W	RV ₂₇	250kΩ	logarithmic (10% law)		R ₄₃	10MΩ	20%	0.25W
R ₁₁	20MΩ	5%	0.25W	R ₂₈	47kΩ	10%	0.25W	R ₄₄	10MΩ	20%	0.25W
R ₁₂	120kΩ	5%	0.25W	R ₂₉	39kΩ	10%	0.25W	R ₄₅	470kΩ	5%	0.25W
R ₁₃	680kΩ	5%	0.25W	R ₃₀	68kΩ	10%	0.25W	R ₄₆	1.5MΩ*	10%	1W
R ₁₄	390kΩ	5%	0.25W	RV ₃₁	250kΩ	logarithmic (10% law)		R ₄₇	270kΩ*	10%	1W
R ₁₅	680kΩ	5%	0.25W	R ₃₂	6.8kΩ	10%	0.25W	R ₄₈	3.9kΩ*	10%	1W
R ₁₆	2.2MΩ	10%	0.25W	R ₃₃	82kΩ	5%	0.25W	†RV ₄₉	100kΩ	logarithmic (10% law)	
R ₁₇	1.5MΩ*	10%	1W					R ₅₀	12kΩ	10%	0.25W

* High-stability carbon. † The mains switch may be combined with this potentiometer.

Capacitors

C ₁	820pF	Silver mica	5%	C ₁₅	2200pF	Silver mica	5%
C ₂	470pF	Silver mica	5%	C ₁₆	0.02μF	Paper	150 V d.c. wkg.
C ₃	120pF	Silver mica	5%	C ₁₇	180pF	Silver mica	5%
C ₄	120pF	Silver mica	5%	C ₁₈	270pF	Silver mica	5%
C ₅	0.1μF	Paper	350 V d.c. wkg.	C ₁₉	180pF	Silver mica	5%
C ₆	50μF	Electrolytic	12 V d.c. wkg.	C ₂₀	470pF	Silver mica	5%
C ₇	0.1μF	Paper	350 V d.c. wkg.	C ₂₁	1800pF	Silver mica	5%
C ₈	8μF	Electrolytic	350 V d.c. wkg.	C ₂₂	820pF	Silver mica	5%
C ₉	0.1μF	Paper	350 V d.c. wkg.	C ₂₃	220pF	Silver mica	5%
C ₁₀	50μF	Electrolytic	12 V d.c. wkg.	C ₂₄	390pF	Silver mica	5%
C ₁₁	0.1μF	Paper	350 V d.c. wkg.	C ₂₅	560pF	Silver mica	5%
C ₁₂	560pF	Silver mica	5%	C ₂₆	0.1μF	Paper	350 V d.c. wkg.
C ₁₃	8200pF	Silver mica	5%	C ₂₇	50μF	Electrolytic	12 V d.c. wkg.
C ₁₄	0.05μF	Paper	150 V d.c. wkg.	C ₂₈	0.01μF	Paper	350 V d.c. wkg.
				C ₂₉	8μF	Electrolytic	350 V d.c. wkg.

SUMMARY OF PERFORMANCE

Sensitivity (220 mV output at 1 kc/s).

Radio/Tape	Input impedance	100 kΩ	100 mV
PU1 LP	Input impedance	100 kΩ	4.0 mV
PU1 78	Input impedance	100 kΩ	5.0 mV
PU2 LP	Input impedance	100 kΩ	50 mV
PU2 78	Input impedance	100 kΩ	60 mV
Microphone	Input impedance	1 MΩ	1.5 mV

Distortion

Total harmonics better than 0.1% on all positions at approximately 200 mV output.

Total harmonics better than 0.2% on all positions at approximately 2 V output.

Intermodulation: see text.

Filters

Low pass at 5 kc/s, 10 kc/s and 20 kc/s, cut off better than 12 dB/octave.

High pass at 35 c/s, cut off better than 12 dB/octave.

Background Noise

Radio/Tape input socket loaded with 100 kΩ:—64 dB.

PU1 input socket short-circuited (PU2 o/c) L.P.:—

(— 53 dB).

PU1 input socket short-circuited (PU2 o/c) 78:—

(— 54 dB).

PU2 input socket loaded with 50 kΩ (PU1 o/c) L.P.:—

(— 55 dB).

PU2 input socket loaded with 50 kΩ (PU1 o/c) 78:—

(— 56 dB).

Microphone input socket short-circuited:—(— 45 dB).

Valves

Mullard EF86 (three).

Switches

SA 2-pole 4-way make-before-break wafer switch.
SB 3-pole 3-way make-before-break wafer switch.

Indicator Lamp

6.3 V, 0.04 A.

Circuit Voltages

Testing Point	D.C. Voltage (V)	Meter Range
C ₂₉	215	1000 V d.c.
C ₃	210	1000 V d.c.
Anode V3	95	1000 V d.c.
Screen grid V3	80	1000 V d.c.
Cathode V3	2	10 V d.c.
Anode V2	90	1000 V d.c.
Screen grid V2	100	1000 V d.c.
Cathode V2	1.8	10 V d.c.
Anode V1	90	1000 V d.c.
Screen grid V1	80	1000 V d.c.
Cathode V1	2	10 V d.c.

The voltages were measured with a Model 8 "Avometer" (20,000Ω/Volt) with zero input signal.

Power Supply

High tension 250 V at 3 mA.
Heaters centre tapped 6.3 V at 0.6 A.

Further Notes on the

F.M. TUNER

Details of the Oscillator Circuit Layout and Notes on Frequency Stability

By **S. W. AMOS**, B.Sc. (Hons.), A.M.I.E.E., and
G. G. JOHNSTONE, B.Sc. (Hons.)

SINCE the publication of the articles on the f.m. tuner in the April and May issues letters received have indicated that further information concerning the layout of the oscillator components may be desirable and the accompanying diagram has been prepared to help constructors. This is an underside view of that part of the chassis immediately surrounding the oscillator coil. It is drawn approximately to scale, and shows that the connecting wires of the capacitors have been cut very short; if this precaution is not taken the inductance of the capacitor wires may cause such a change in effective reactance that the required oscillator frequency and coverage may be unobtainable.

In the prototype f.m. tuner best oscillator stability was obtained with the negative-temperature coefficient capacitor C_9 enclosed in the screening can of the inductor L_4 but some layout changes were made in produc-

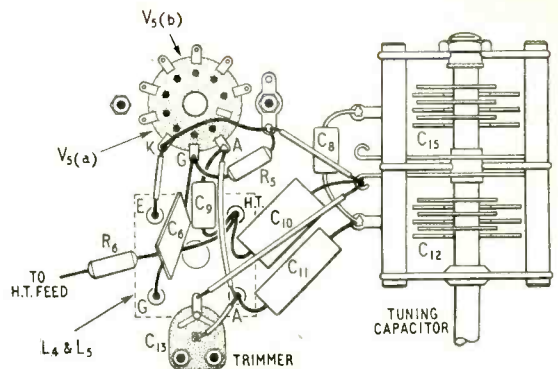

Underside view of the chassis immediately surrounding the oscillator showing exact relative position of all components in this circuit. Note that the oscillator coil has been turned through 180 degrees.

ing the model which was photographed for the May issue and subsequent experience with this model has shown that stability is best with C_9 underneath the chassis and soldered directly to the anode tag of oscillator valveholder, as shown in the diagram. The anode lead of the capacitor should be cut to approximately $\frac{1}{2}$ in in length before soldering the component in position. In order to accommodate C_9 at this point it was found convenient to rotate the oscillator coil through 180 degrees from the position shown in the photographs. The accompanying layout diagram illustrates this reorientation.

Repeat Performance: *Mr. Briggs Does it Again*

THE seating capacity of the Royal Festival Hall was again unequal to the demand for tickets for G. A. Briggs' second London lecture-demonstration of sound reproduction on May 21st. The programme followed broadly the lines of last year's demonstration (reported in our December, 1954, issue) with the addition of live and recorded choral singing and an excerpt from a tape recording in the Festival Hall of a public concert, played back at exactly the same acoustical level as the original. Drawing on his fund of experience as a loudspeaker manufacturer and a musician, Mr. Briggs once again delighted his audience with a wise and witty commentary.

The accompanying photograph, taken from behind the loudspeakers during Thurston Dart's harpsichord recital, shows (on the extreme right) a

section of the Goldsmiths' Choral Union, and about a third of the Festival Hall audience.

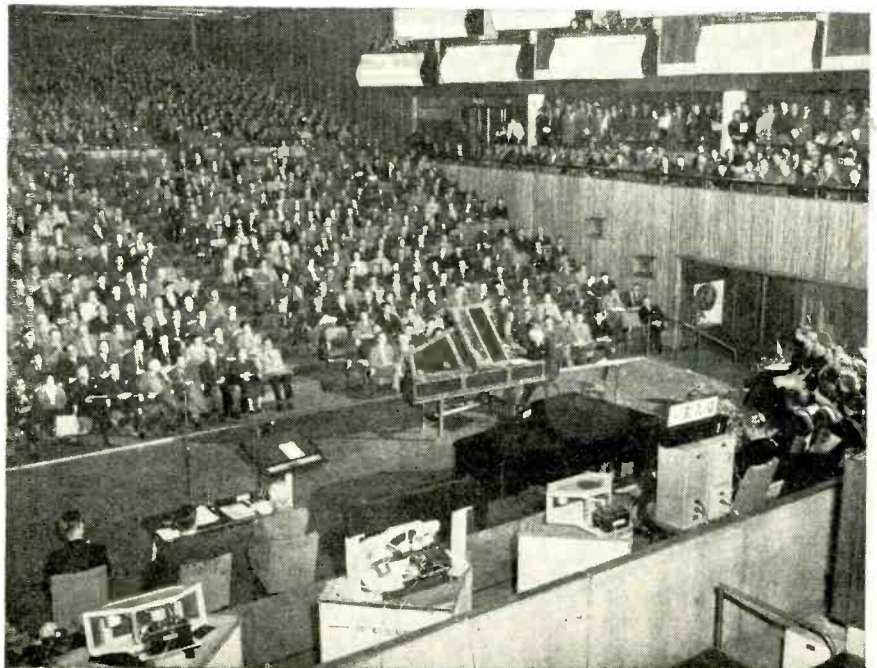

Transistor Equivalent Circuits

1.—Introductory Derivation of Valve Circuit

By W. T. COCKING, M.I.E.E.

SUMMARY:—In the series of articles of which this is the first, some equivalent circuits for the triode transistor are developed. In order that this development may be fully understood, the method of finding equivalent circuits is first explained in detail for the familiar thermionic valve. This also establishes the necessary conventions for current and voltage. It is shown that, within the usual limits of straight-line approximation to the valve characteristics, the valve equivalent circuit is valid for static d.c. conditions as well as for a.c.

AT the present time, transistor literature is very confusing to the newcomer. The physics of the transistor is extremely difficult; few people have any real understanding of it and, most certainly, no one knows all about it. It may well be years before the internal action of the transistor is as readily understandable as that of the valve.

In the meantime we have to use the transistor and it is fortunate that we can do so without knowing anything about what goes on inside it. As it reaches us from the manufacturer, the transistor is a small object having three wires labelled emitter, base and collector. By making measurements at these wires we can find out all we want to know about the transistor in order to use it. We can apply known voltages and measure the resulting currents. We can then plot families of characteristic curves and we can devise equivalent circuits.

An equivalent circuit is one which behaves in the same way as the real circuit or apparatus as far as it is possible to determine it by external measurement. If an exact equivalent circuit of a transistor could be constructed from an assemblage of ordinary components, then if all these parts were enclosed in a box it would be impossible to distinguish it from a real transistor by any external measurement. We could not tell whether the box contained the equivalent circuit or the real thing.

In practice, it is rarely possible to achieve exact equivalence. Only approximate equivalence can be reached. Usually, the approximation is a good one so long as the voltages and currents at the terminals are kept within certain limits; it may be, too, that it is good only as long as the operating frequency is kept below a certain figure.

Very commonly, the approximate equivalent circuit holds only for alternating voltages and currents and does not hold at all for d.c. operating conditions. It is then strictly called the a.c. approximate equivalent circuit. This is the kind with which we are all familiar in connection with the thermionic valve and it is the sort that is usually derived for the transistor.

This a.c. equivalent circuit is adequate for most practical purposes and it is usually derived directly, without any regard for the d.c. conditions. This at

once introduces all sorts of possibilities for the convention to be adopted for the direction of current flow and so on. A great deal of confusion can be avoided by keeping the d.c. conditions firmly in mind the whole time; indeed, there are advantages in deriving first a d.c. equivalent circuit, extending it to cover a.c. and d.c., and only then dropping the d.c. conditions. This is an unorthodox approach, but one which is very helpful.

The current and voltage convention often causes difficulty in the literature on transistors, because authors do not always make it clear which one they adopt. Another difficulty which confronts the beginner is that transistor circuit theory is usually completely divorced from valve circuit theory. This seems to be a deliberate policy with some writers. They seem to think that the transistor is so different from the valve that its circuit theory must be a distinct subject.

This is, of course, quite contrary to the principles of economical teaching. However different the valve and the transistor may be in their internal form and internal operation, they are not very different from the point of view of basic circuit theory. In fact, the transistor is very nearly equivalent to a valve with internal feedback and, in some cases, a valve circuit can be produced which has precisely the characteristics of the transistor. It seems to the writer, therefore, that the best approach to transistor circuit theory is *via* valve circuit theory and that it should be treated as merely an extension of the latter.

In these articles, several equivalent circuits for the transistor will be derived and the relations between them demonstrated. This is an essential pre-requisite for discussing transistor circuit theory, but we shall not here go into circuitry at all deeply.

Many people are not very familiar with the methods of deriving equivalent circuits and it is best to start, therefore, by deriving the rather familiar equivalent circuit for the thermionic valve. Because they are accustomed to the valve and to its equivalent circuit,

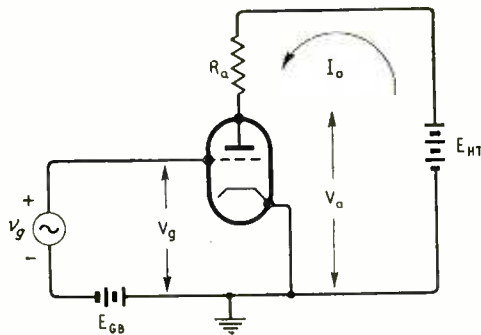

Fig. 1. Basic triode valve circuit.

the method of deriving the latter will be much more easily understood than if the procedure were applied straight away to the transistor.

A typical triode valve circuit is shown in Fig. 1. In the grid circuit there is a generator of alternating voltage v_g and a grid-bias battery E_{GB} . The grid potential with respect to the cathode is

$$V_g = v_g - E_{GB} \dots \dots \dots (1)$$

The polarity of v_g shown in Fig. 1 refers, of course, to the positive half-cycle in accordance with the usual convention.

In the anode circuit there are a load resistance R_a and an h.t. battery E_{HT} . The anode potential with respect to the cathode is

$$V_a = E_{HT} - I_a R_a \dots \dots \dots (2)$$

These relations apply to the external circuit of the valve and must also apply to the external circuit of any equivalent circuit which we use to represent the valve.

The relations between V_g , V_a and I_a depend upon the valve itself and can be measured for any specimen. We can, for instance, keep V_g at some fixed value and measure the current I_a for a series of values of V_a . We can then change V_g to some other value and repeat the measurement. When the results are plotted as a graph, we obtain a family of anode-voltage—anode-current curves, each curve for a different value of grid voltage. It is usual for the curves to represent equal changes of grid voltage.

A typical family of such curves is shown in Fig. 2. In the higher-current regions, the curves approximate closely to equally-spaced parallel straight lines but, in the lower regions, they depart considerably from this. The dotted equally-spaced parallel lines in Fig. 2 thus represent a good approximation to the real valve curves over the limited region where the two nearly coincide.

It is possible to draw such nearly-coincident straight lines anywhere on the graph but, in regions where the real curves are considerably bent, the approximation will be good only within a very small region.

It can be seen from Fig. 2 that, if the values of V_a , V_g and I_a are such that the operation is confined to the region where the straight lines approximate the real curves closely, we can assume that the straight lines do represent the valve characteristics with very little error. An approximation of this nature is at the basis of all normal valve equivalent circuits, which is why they are usually said to be valid only for small signals. In the practical use of equivalent circuits this restriction is always implicit, but, in deriving them, we can forget it.

In deriving the equivalent circuit, we can regard the dotted lines of Fig. 2 as representing the characteristics of an ideal valve, and we use only these ideal characteristics. If we examine Fig. 2, it will be clear that one particular line (which may, or may not, actually be drawn) for one particular value of V_g , will pass through the origin. This line is the graphical representation of a resistance of value $V_a/I_a = \delta V_a/\delta I_a = r_a$, where δ means a very small change in the value of the quantity to which it is pre-fixed. Since the lines are all parallel $\delta V_a/\delta I_a = r_a$ is the same for them all, but V_a/I_a is not only different for all other lines but varies for all points along them. The value of r_a corresponds to the normal definition of the a.c. resistance of a valve, and is the a.c. resistance of an ideal valve. The d.c. resistance is constant only for the

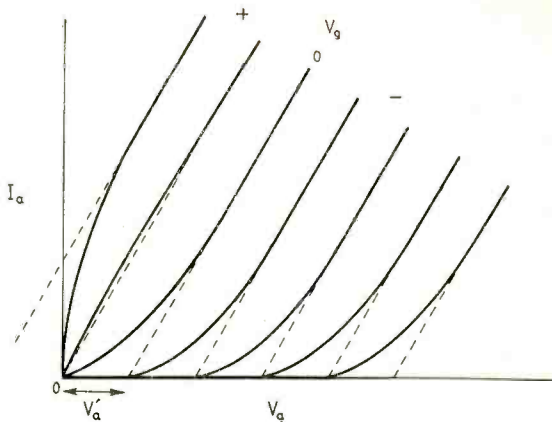

Fig. 2. Typical triode characteristics are shown by the full-line curves and an idealized approximation to them by the dotted lines.

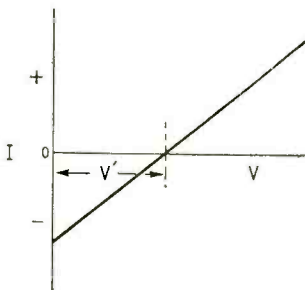

Fig. 3. Single characteristic similar to any dotted line of Fig. 7, but extended to negative current

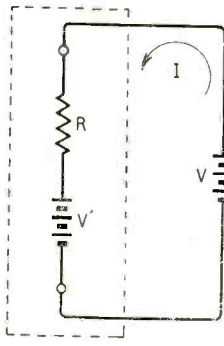

Fig. 4

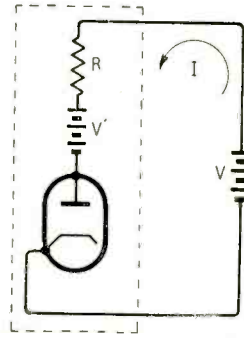

Fig. 5

Fig. 4. Circuit giving exactly the characteristic of Fig. 3. Fig. 5. An ideal diode added to Fig. 4 prevents the negative current of Fig. 3 and gives the circuit a characteristic like a dotted line of Fig. 2.

line passing through the origin and it is then the same as the a.c. resistance.

Now, if we were presented with a device in a sealed box with two accessible terminals and, by applying a series of external voltages to it and measuring the resulting current, we obtained a characteristic like Fig. 3, we should conclude that the box contained a resistance and battery in series. We should say that the resistance had a value $R = \delta V/\delta I$ and that the battery had a voltage equal to the intercept of the characteristic with the zero current axis and acted to

oppose the applied voltage. We should unhesitatingly adopt the equivalent circuit shown boxed in Fig. 4 with the convention for direction of current and battery polarity shown.

The characteristic of Fig. 3 is, however, identical with any one of the ideal ones of Fig. 2, with the exception that negative current does not occur in the latter. Apart from this, therefore, the representation of Fig. 4 must hold for Fig. 2 as well as for Fig. 3. We can take care of the discrepancy of there being no negative current by supposing an ideal diode to be in series with R and V', as in Fig. 5. This would represent exactly the ideal characteristics of Fig. 2. The resistance R of Fig. 5 is clearly equivalent to the a.c. resistance r_a of the ideal valve and the battery voltage V' governs the position of a line.

For $V_g = 0$, this battery voltage is clearly V'_a (Fig. 2) the intercept of the zero grid-volts line with the zero-current axis. For any other grid voltage, it has a value dependent on the grid voltage. The amplification factor of a valve is normally defined as

$$\mu = -\delta V_a / \delta V_g$$

for constant anode current. The quantity $-\delta V_a$ is the change of anode voltage needed to maintain the anode current unchanged when the grid voltage is altered by the amount δV_g . In spite of the minus

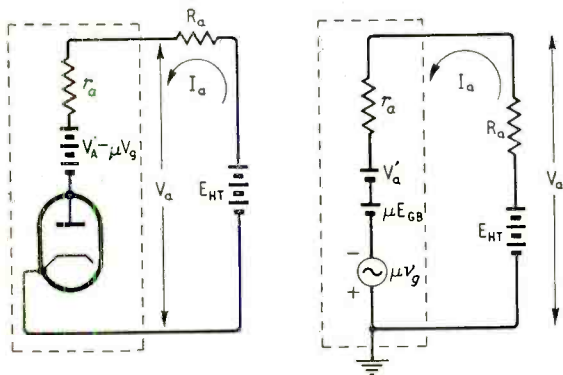
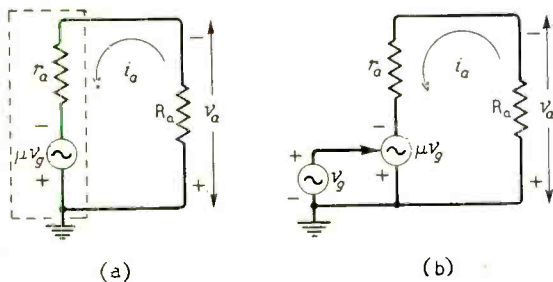

Fig. 6

Fig. 7

Fig. 6. This is the same circuit as Fig. 5, but the internal battery is changed to represent Fig. 2.

Fig. 7. This circuit is an equivalent of Fig. 1, valid for a.c. and d.c. conditions as long as the voltages are such that the dotted-line approximation to the real valve curves in Fig. 2 is a good one.



(a)

(b)

Fig. 8. Here the a.c. equivalent circuit alone is shown, the a.c. elements being dropped out. The usual form is (a) but the generator is sometimes drawn as in (b).

sign, μ is a positive number for, if δV_a is itself positive δV_g is necessarily negative and vice versa.

With the ideal characteristics shown in Fig. 2, it is clear from the geometry that the spacing of the intercepts on the V_a -axis of the lines for various values of V_g , is μ times their spacing in terms of V_a . It follows that the value of V' for any line is

$$V' = V'_a - \mu V_g$$

The minus sign is required because a positive value of V_g reduces the value of the equivalent battery, while a negative value increases it.

Complete Equivalent Circuit

The equivalent circuit of the valve with its load resistance R_a and h.t. supply E_{HT} thus takes the form shown in Fig. 6. It is an exact equivalent of Fig. 1 if the valve used in Fig. 1 has the ideal characteristics of the dotted lines in Fig. 2. If one could have such a valve, it would not be possible to distinguish Figs. 1 and 6 by any measurements on these circuits.

With a practical valve, the equivalence is valid only in so far as the approximation of the dotted straight lines to the real valve curves is a good one. The equivalent circuit is thus useful only when V_g , V_a and I_a are restricted to values for which the approximation is good. This usually means that the anode current must not be too small. If we restrict the use of the circuit to these conditions, the anode current will always be positive and so the diode in Fig 6 is unnecessary. This was only put in to prevent negative current from flowing with an unrestricted range for V_g and V_a and, with a restricted range, it is no longer required.

We can, therefore, redraw Fig 6 as Fig 7. Here we have, as well as omitting the diode, replaced V_g by $v_g - E_{GB}$ in accordance with equation (1). The valve is thus equivalent to r_a in series with the off-setting voltage V'_a of Fig. 2, a voltage μE_{GB} and a generator μv_g , which represent in the anode circuit the effect of E_{GB} and v_g of Fig. 1 in the grid circuit.

The total voltage acting around the circuit of Fig. 7 is

$$E_{HT} + \mu v_g - \mu E_{GB} - V'_a$$

The symbols here all represent the magnitudes only of the voltages when the polarities are as indicated in the figures.

The equation for current is thus

$$I_a = \frac{E_{HT} - \mu E_{GB} - V'_a + \mu v_g}{R_a + r_a} \dots \dots (3)$$

and V_a is given by equation (2).

The voltage is made up of two components, μv_g , an alternating voltage, and $E_{HT} - \mu E_{GB} - V'_a$, a steady voltage. As the circuit is a linear one, within the limits of our approximation, we can similarly express the current I_a as the sum of an alternating current i_a and a direct current I_{am} , and we can separate out the a.c. and d.c. components of equation (3) and so get

$$i_a = \frac{\mu v_g}{R_a + r_a} \dots \dots (4)$$

and

$$I_{am} = \frac{E_{HT} - \mu E_{GB} - V'_a}{R_a + r_a} \dots \dots (5)$$

We can do the same thing for equation (2) and re-

gard V_a as the sum of an alternating component v_a and a steady component V_{am} . This gives

$$v_a = -\mu v_g \frac{R_a}{R_a + r_a} \dots \dots \dots (6)$$

and

$$V_a = E_{HT} - (E_{HT} - \mu E_{GB} - V'_a) \frac{R_a}{R_a + r_a} \dots \dots (7)$$

Equations (5) and (7) are the d.c. ones and apply to Fig. 7 if the generator μv_g is absent. Equations (4) and (6) are the a.c. ones and apply to Fig. 7 if all the batteries are removed, leaving μv_g only. The a.c. equivalent circuit thus takes the form shown in Fig. 8(a) and is the one with which we are all familiar. Some people prefer to draw it in the modified form of Fig. 8(b) in order to show v_g itself, but this form means exactly the same thing.

In Fig. 8, the restriction on the direction of current flow has disappeared. Current flows in both directions, on alternate half-cycles. This is because it now represents only the a.c. condition and it is implicit in the derivation that the peak value of current shall not exceed the mean direct current in Fig. 7, otherwise a reversal of current in Fig. 7 would be required and this cannot be allowed. To put it another way, in Fig. 7 i_a must always be less than I_{am} and usually a good deal less for the approximation behind the whole equivalence to be reasonably good.

Exactly the same form of representation is valid for a pentode valve. The full-line curves of Fig. 9 are typical of a pentode and the dotted lines indicate an ideal approximation to them. The voltage V'_a , which settles the position of the zero grid-volts line is very large and negative for a pentode, whereas it is small and positive for a triode. The battery V'_a in Fig. 7 thus reverses its polarity to a pentode.

If one wishes to determine V'_a from a graphical construction it is awkward to do so directly with a pentode, because V'_a is so large. It is much easier to determine it indirectly from the value of r_a and the current I'_a , at which the ideal zero grid-volts line cuts the current axis, and compute it from $V'_a = -I'_a r_a$.

It will probably surprise many that it is possible to represent the d.c. conditions of the valve by an equivalent circuit in this way. The equivalent circuit is valid and precise only in so far as the ideal straight lines approximate to the real valve characteristics and the anode current must never be permitted to become negative.

Some people object to the a.c. representation of Fig. 8 on the grounds that it depicts the valve as having an internal source of e.m.f. and the real valve has not. These people will presumably object even more to Fig. 7, which shows not only an a.c. generator but batteries within the equivalent valve.

The real justification for Fig. 7 is this. The equivalent circuit comprises an assembly of real practical elements. It would be possible to assemble it from real components. If one did so and boxed it up, as it is shown boxed in Fig. 7, it would not be possible to distinguish its contents from a real valve by any external measurements as long as the resulting voltages and currents were kept within the limits necessary for the validity of the representation. If they were allowed to stray outside those limits, of course, it would be easy enough to distinguish between them.

In practice, it is the a.c. equivalent circuit that is nearly always the one to be used. There are occasions,

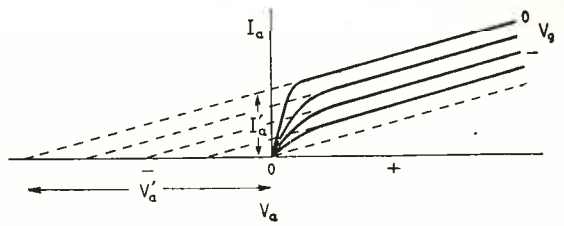

Fig. 9. Typical pentode characteristics are shown by the full-line curves and an idealized approximation by the dotted lines.

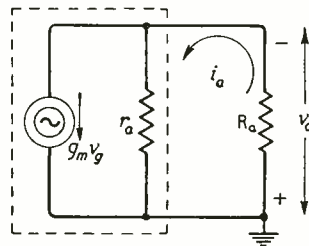

Fig. 10. Alternative form of a.c. equivalent circuit using a constant-current generator instead of a constant-voltage.

however, when the d.c. circuit is useful. Provided one keeps within the linear range, it is helpful in d.c. amplifier design and in some time-base circuits, where a capacitor is charged through a valve.

By means of Norton's theorem, the a.c. equivalent circuit of Fig. 8 can be changed to the form of Fig. 10, in which a constant-current generator $g_m v_g$ replaces the constant-voltage generator μv_g . Here g_m is the mutual conductance and equals μ/r_a . This is a very common and convenient form of circuit, especially for pentode valves, for which r_a is usually very high in value.

(To be continued)

CLUB NEWS

Barnsley.—The use of mobile equipment will be discussed by T. Foster (G3GAH) at the meeting of the Barnsley and District Amateur Radio Club at 7.0 on July 22nd at the King George Hotel, Peel Street, Barnsley. Sec.: P. Carbutt (G2AFV), 33, Woodstock Road, Barnsley, Yorks.

Birmingham.—J. Missen, of the G.E.C. Research Laboratory, will be speaking about transistors to members of the Midland Amateur Radio Society at their July meeting. Visitors are welcome to the Club's meetings which are held at 7.15 p.m. on the third Tuesday of the month at the Birmingham and Midland Institute, Paradise Street, Birmingham. Sec.: D. Hall, 144, Hill Village Road, Sutton Coldfield.

Chelmsford.—"Test Gear for Amateur Television" is the title of the lecture to be given by R. Martyr at the next meeting of the Chelmsford group of the British Amateur Television Club. It will be held on July 14th at 10, Baddow Place Avenue, Gt. Baddow, Essex. Sec.: D. W. Wheele, 4, Bishop Road, Chelmsford, Essex.

Downham (Kent).—The Ravensbourne Amateur Radio Club (G3HEV) meets on Wednesdays at 8.0 in the Science Room, Durham Hill School, Downham. Courses are run in preparation for the Radio Amateurs' Examination under the club instructor, G. V. Haylock (G2DHW). Sec.: J. Wilshaw, 4, Station Road, Bromley, Kent.

QRP Contest.—The QRP Society is holding a portable amateur radio equipment contest (open to non-members) which is to be judged in four classes—hand and mobile communications gear, transistor sets and test gear. Rules for the contest, entries for which must be received by September 30th, and information regarding the Society are obtainable from the secretary, John Whitehead, 92, Rydens Avenue, Walton-on-Thames, Surrey.

Compact Tape Recorder

MANY INGENIOUS FEATURES IN THE
NEW PHILIPS "RECORDERGRAM"

OPERATING with a fixed tape speed of $3\frac{3}{4}$ in/sec the Philips Type AG8105 tape recorder gives a total of 1 hour's playing time from the two tracks of a 600ft (5 inch) reel of standard tape. It conforms to the B.S. convention of left-to-right motion of the tape, using the top track with the active side away from the observer.

For a complete recording machine it is remarkably compact $13\frac{1}{2}$ in \times $7\frac{1}{2}$ in \times 10 in and weighs only 21 lb. It bristles with ingenious ideas and one of the most obvious is the centralized control knob giving a choice of seven functions. For fast running—either forward or in reverse—the knob is depressed through a safety gate; the other functions are selected by rotation, with a subsidiary check to prevent accidental erasure when passing from the playback to the recording positions.

If desired the internal amplifier can be used for reproducing gramophone records. Another very convenient feature is that when tapes are being played back, a voltage output appears at the pickup terminals and can be applied to an external amplifier and loud-speaker system of greater power-handling capacity. The internal loudspeaker continues to function as a monitor.

There are only two valves in the main amplifier, a double triode and an output pentode. There is also a cathode-ray level indicator and, of course, a power

View of the chassis with screening removed to show the driving motor.

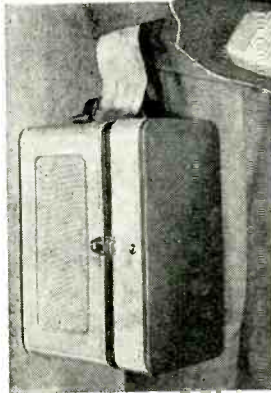
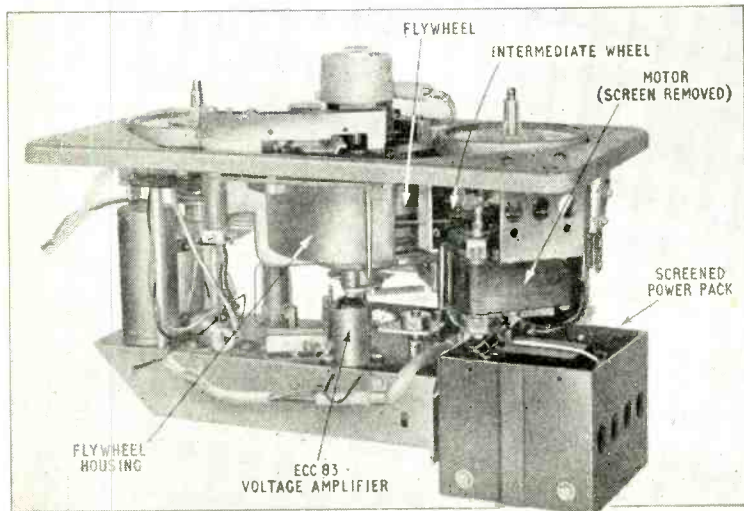

Accessories include a 600-ft reel of tape and a crystal microphone. A dummy socket is provided in the top left-hand corner of the lid to carry the mains plug.

Weighing only 21 lb, the "Recordergram" can be carried without undue strain.

rectifier. Although the available voltage amplification appears to be less than normal it should be borne in mind that the coercivity and saturation levels of modern tapes are high, and that by accepting a moderate power output, sufficient for the small internal loud-speaker, a perfectly satisfactory performance is obtained without danger of overloading the tape.

The loudspeaker incidentally is fitted with a ceramic ("Magnadur") magnet.

Tape Mechanism.—A dynamically-balanced high-speed induction motor drives a large flywheel through

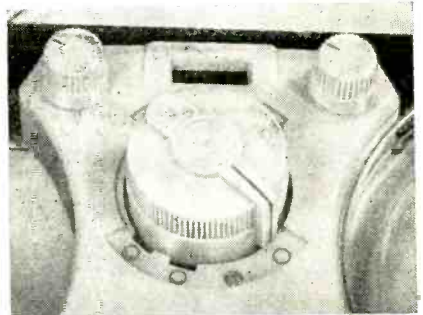

Above: Main control knob with seven positions:—(1) "off," (2) amplifier only, (3) fast forward, (4) fast rewind, (5) playback, (6) recording from inputs other than microphone, (7) recording from microphone. The two small knobs control separately the levels for recording and playback.

an intermediate friction wheel, which is disengaged in the "off" position through a link mechanism from the central control knob. The supply and take-up spool spindles are driven at constant speed by a round spring belt from a groove in the flywheel. On each spindle are mounted a pair of concentric discs, carrying felt pads in their upper surfaces. The discs are connected by a flexible diaphragm, rather like a loudspeaker dust-proof centring device, which permits relative vertical movement between the planes of the felt pads. Resting on one or other of these pads is the spool turntable which is provided with a bronze-bushed polythene centre boss and is free to rotate on the spindle.

When the control is set for recording or playback the inner, small-diameter pads are highest and engage the underside of the polythene centre boss, giving just sufficient friction (in opposite directions), to take up

the slack in the tape without imposing too much load on the capstan drive. There is always some slip between the turntables and their spindles. When the control is depressed for fast forward wind or for re-wind, one or other of the centre felt rings is retracted, allowing the outer felt pads to engage the turntable on a much larger diameter, giving a more positive drive with slip only during the speeding-up process.

The tape gate is a hinged die casting which carries the pinch roller, pressure pads and a segment of high-permeability alloy which closes behind the tape and completely screens the record/playback head except for the two narrow slots to pass the tape.

To prevent trouble from "sticky" tapes, a deflector is mounted close to the capstan on the exit side.

Circuit.—When used for recording from a gramophone pickup or microphone the two triode stages

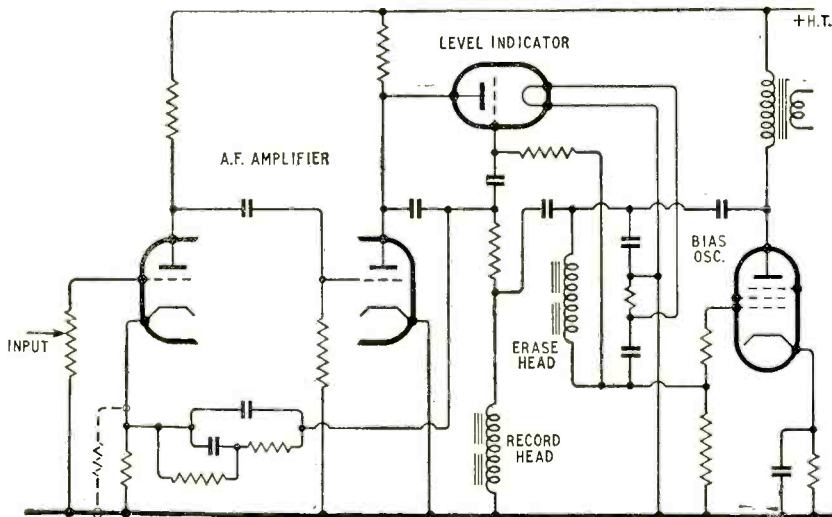

Simplified diagram showing essential features of the circuit when switched to "record."

provide the few milliwatts of audio power required by the recording head. Feedback is applied through a frequency-dependent R-C circuit to give a relative rise at low frequencies. In the microphone position of the control switch, the cathode resistor of the first stage is shunted to reduce feedback and increase gain. The output pentode is used as bias oscillator in a Colpitts circuit, with the erase head itself as the frequency-determining inductance and the output transformer primary as the parallel feed impedance. A resistor of a few ohms is inserted at the earthy junction of the tuning capacitors and the filament of the tuning indicator is connected across it. Thus the level indicator also shows that bias and erase current is being generated.

On playback the head is tuned by a parallel capacitor to a frequency of 6 kc/s to give top lift. The bass lift feedback circuit used for recording stays in circuit for playback to give overall compensation for the 6-db/octave slope inherent in magnetic recording.

Performance.—Although the nominal frequency range is only 100 c/s to 6 kc/s, live recordings give the impression of a much wider response, and a test confirmed that the full compass of the piano can be recorded without any noticeably wooden tone in the treble and with a full

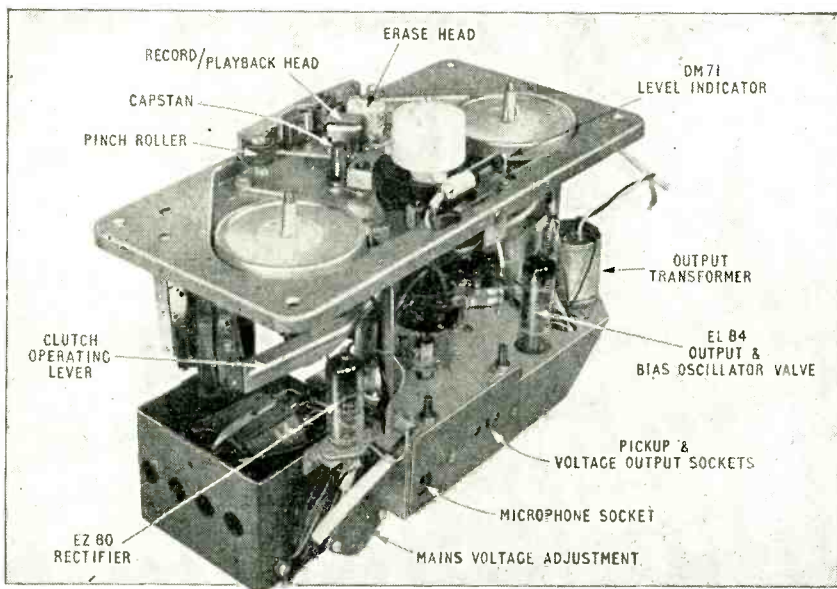

The power pack (left foreground) is mounted separately from the main chassis, but is lifted by tags which engage in slots in the chassis when the "works" are extracted from the case.

round tone at three octaves below middle C where "the book" says the fundamental should be 33 c/s!

The piano is one of the severest tests that can be applied for wow and flutter, and one must not expect the performance in this respect to achieve the standard of studio equipment costing hundreds of pounds. In the machine tested there was a flutter at higher than capstan speed and some tape whistle, which we understand has now been remedied by a modification to the pressure pad. Neither of these faults was sufficient to detract from the value of the recorder as a medium of musical self-criticism.

Of the hundred and one uses to which this machine will be put it is safe to say that ninety-nine will prove entirely satisfactory. Speech quality is very good and some excellent records of bird song were included in the many samples taken of familiar sounds.

The expected difficulties arising from the small number of valves did not materialize. All one had to do was to work in the top third of the level control range rather than in the middle to avoid bringing up the hum level; there were fewer spoilt recordings due to overloading the tape during the initial stages of learning to handle the controls.

No trouble was experienced with the tape transport system, and a special word of praise is due to the fast winding mechanism and the sweet action of the turntable brakes, which combine to make the finding of any given part of the tape a much less frustrating operation than in the majority of tape mechanisms.

At £36 15s the "Recordergram" is excellent value

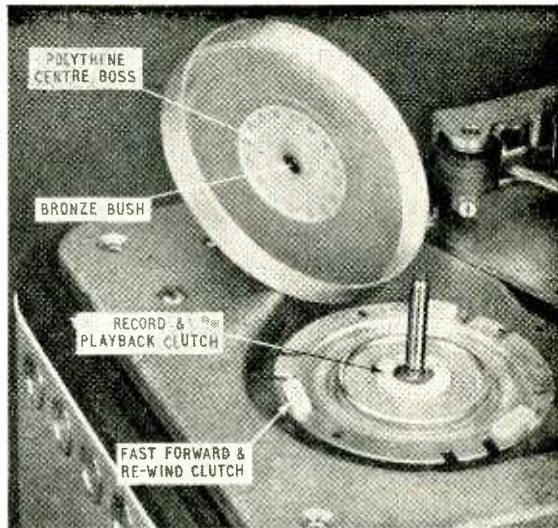

Turntable removed to show normal and fast-running felt friction pads.

for money, and the makers, Philips Electrical, Ltd., Century House, Shaftesbury Avenue, London, W.C.2, are to be congratulated on the ingenuity of their response to a growing popular demand.

TRANSISTOR RESTORATION

Re-forming a Damaged OC51

DURING a series of experiments with an OC51 point transistor in a simple frequency-changer stage excessive current was allowed to flow due to the inadvertent reduction to zero of the variable resistance in the emitter circuit. This resulted in the transistor being damaged to such an extent that, when inserted in a simple detector stage, it refused to function and no collector current was taken.

Subsequent tests showed that the transistor, when in the same circuit with the supply disconnected, operated as a crystal detector. This, coupled with the fact that, when a meter and 1.5-volt battery were connected between the emitter and collector, an open-circuit was shown, led to the conclusion that the transistor was operating as a double diode. So, on the basis of nothing ventured nothing gained, an attempt at re-forming the collector was made.

The methods of forming home-made transistors were studied and the damaged transistor subjected to the recommended "shock treatment," consisting of discharging a 0.1 μ F capacitor between the collector and base connections. The first discharge was from a capacitor charged at approximately 200 volts and the transistor was then inserted into a simple receiver circuit incorporating a meter in the collector supply. On connecting the supply, the meter was observed to flicker, thereby proving that the treatment was having effect.

The transistor was then subjected to further shocks, at the same voltage. Between each discharge it was

replaced in the receiver circuit and the collector current observed to rise slowly. When the current was still below that normally drawn by a good transistor and further rise unobtainable, the voltage was increased to 250 volts and the procedure repeated. After approximately four such discharges the current approached that of a good transistor and it was decided to test the transistor's operation by connecting the aerial to the receiver circuit employed to measure the current during the re-forming operations.

It was found that the re-formed transistor now operated quite well as a detector on the medium wave band and reaction could be obtained. When the voltage was increased to that normally employed before the damage and reaction applied, the transistor oscillated violently and the collector current rose rapidly, but on decreasing the reaction normal operation was possible.

The next test was in an amplifier stage and the transistor performed quite normally with no tendency to oscillate. Operation in an r.f. stage was tried next, but with poor results, due to violent oscillation, which appeared to be caused by the fact that the value of emitter bias was now critical and the transistor a little unstable.

It appears that the transistor is now operating on a slightly different characteristic to normal, but as the re-forming of the collector has been successful, this, for certain applications, need not be discouraging.

R. T.

Valve Curve Diagrams

Understanding the Significance of Load and Other Lines

By "CATHODE RAY"

LAST month, in discussing cathode followers, I made use of certain valve curve diagrams. It has occurred to me that there may have been readers who quickly shied off at that stage, or, seeing the diagrams in advance, were non-starters. Others, though less easily deterred, may through unfamiliarity have found them somewhat baffling, notwithstanding the clues I scattered as freely as space permitted.

The first thing that has to be explained, perhaps, is why it is considered necessary to use up a lot of paper and drawing effort in this way instead of dealing with valve problems in a neat equation or two. The reason is that valves do not behave in ways that can be represented accurately by neat equations. They are not like resistors and capacitors and air-core inductors. Oh, I know there is such a thing as an "equivalent generator" by which certain valve calculations can be reduced to simple algebra, but (a) that method takes account only of signal currents and voltages, so is no use at all for finding the best working conditions, such as grid bias voltage, and (b) it doesn't even deal with the signal part accurately, because it ignores the curvature or non-linearity of valves. In any case, certain types of mind are more brightly illuminated by a graphical diagram than by a row of equations.

In equations, quantities such as voltage and current are represented by letters or numbers (depending on whether their values are being dealt with in general or particular). On diagrams they are represented by distances on the paper. I am assuming it is well known how two such quantities are represented by distances respectively horizontal and vertical. Even tired busi-

ness men understand this, when the two quantities are such things as time and commission on sales. But while we may all understand how it applies to voltage and current (for example, anode current and grid voltage), what may not be quite so clear is how resistance, conductance and power can also be represented on the same diagram, or how several different voltages in a circuit can be shown.

If one were to repeat Ohm's original experiment, plotting the current passing through a piece of wire, against the voltage between its ends, the resulting graph would be the kind of thing shown as Fig. 1—a straight line passing through the "origin" (0). (Of course Ohm himself knew nothing about volts and amps, but we might as well make use of our modern units.) The information conveyed by this line could be presented with much less effort as an equation: $V=3I$. Except for the number, the equation would be the same for different pieces of wire; a shorter length of the same wire would give a smaller number than 3, and vice versa. If "V" is being used to denote the potential difference in volts, and "I" the current in amps, the number is the resistance in ohms. The smaller the resistance, the steeper the line in the graph. If that fact is not obvious, try one or two different lines, and consider why the slope of the line is connected with the resistance in this way. The reason, of course, is that resistance in ohms can also be regarded as volts per amp. So the resistance represented by a line on a current/voltage graph is equal to the number of volts it slopes along the voltage scale for each amp up the current scale. In other words, resistance is the ratio of voltage to current, and on a graph the slope or gradient of a line is the ratio of vertical movement to horizontal movement or in this case current to voltage.

The easiest figures for finding the resistance in this example are 3 volts and 1 amp, but because the line is straight—representing a *linear* resistance—the differences in volts and amps between *any* two points on the line would do. If the resistance were not linear, the slope of the line, and the resistance, would vary with current (or voltage).

So not only the value of a resistance but also whether or not it is linear, is clearly shown on a current/voltage graph.

And because conductance is the ratio of current to voltage, it is shown too; the steeper the slope the *greater* the conductance. The mutual conductance of valves is, in fact, often called slope.

Representing Power

How about power? It is current multiplied by voltage. Horizontal distance multiplied by vertical distance gives the area enclosed by the vertical and horizontal lines at each end. For example, the power released in our wire when 1 amp flows through it (i.e., 3 watts) is represented by the shaded area. With a shorter piece of wire, only 1 volt might be needed to

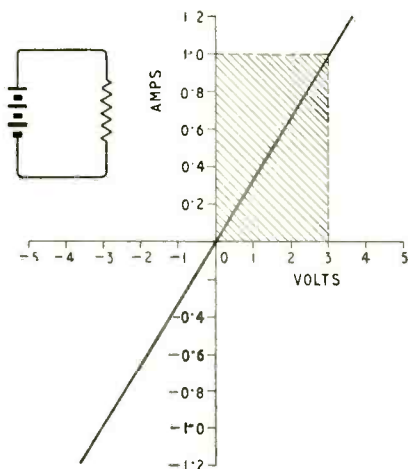

Fig. 1. Graph of current against voltage for linear resistance, represented by the diagonal line. The power used up in it when 1 amp is flowing is represented by the shaded area. Negative currents and voltages are in the reverse direction in the circuit.

pass 1 amp, and the corresponding area would be one-third the size, representing $1 \times 1 = 1$ watt. Equal powers in different resistances are represented by equal areas of different shapes.

Incidentally, if the voltage in Fig. 1 were doubled, from 3 to 6, the area would obviously be *four* times as big. The diagram helps the weaker brethren to visualize the fact that (with a linear resistance) the power dissipated is proportional to the *square* of the voltage (or current).

Our Fig. 1 line represents a certain resistance or conductance, but does not by itself reveal the actual current flowing in it. That depends on the voltage, which we do not know. It might be anything. What the line does show is that if 3 volts were applied the current would be 1 amp. Suppose we don't know the voltage applied to this 3-ohm resistance, but we do know the total voltage applied to it and another known resistance in series. With linear resistances it is a simple exercise in Ohm's law to calculate the voltage across each resistance and the current through both. With non-linear resistances, to which Ohm's law doesn't apply, we would probably be stuck—if we didn't have the graphical method to fall back on. But before taking a non-linear example, let us first try a linear one, which we can check by calculation.

Two Resistances

Suppose 8V is applied to our 3Ω in series with 10Ω . We know that the resulting state of affairs must be represented by a point *somewhere* on the resistance line in Fig. 1. It must also simultaneously be on a line representing the 10Ω . If we were to draw a 10Ω line through 0, that would be the only point common to both lines, and of course it would not represent the situation at all. The clue is the fact that the voltage applied to the 3Ω is 8V *minus* whatever is dropped in the 10Ω . The voltage dropped in the 10Ω is, then, from the point of view of the 3Ω , a negative one, beginning at 8V. So we draw the 10Ω line as shown dotted in Fig. 2. To emphasize that there is nothing wrong about putting the zero-current point at 8V, I have added a second voltage scale to apply to this resistance. The dotted line shows on this scale the voltage to be deducted from 8V to give the voltage across the rest of the circuit, whatever the current.

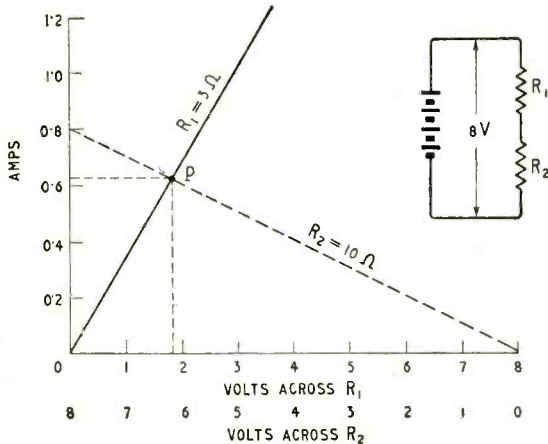

Fig. 2. A circuit with two resistances in series can be investigated by adding a second resistance line, sloping from the point representing the total voltage.

The point *p*, where the two lines cross, is the only one common to both, and indicates that the current through both must be 0.615A, the voltage across the 3Ω must be 1.85, and across the 10Ω , 6.15. Having checked this by calculation, we can have some faith in the graphical method and go on to apply it to situations where calculation fails.

But before we do that, let us see how Fig. 2 can be used to answer different kinds of questions. If we knew the value of the current but not R_2 , it could tell us what R_2 would have to be. Try it for $R_1 = 3$ and $I = 0.5$. In this case the point on the R_1 line is fixed by the fact that $I = 0.5$, so what we have to do is lower the slope of the R_2 line to make it pass through that point and then find what resistance it represents.

Or suppose we are told to find the value of R_2 that results in 2 watts being dissipated in R_1 . That means

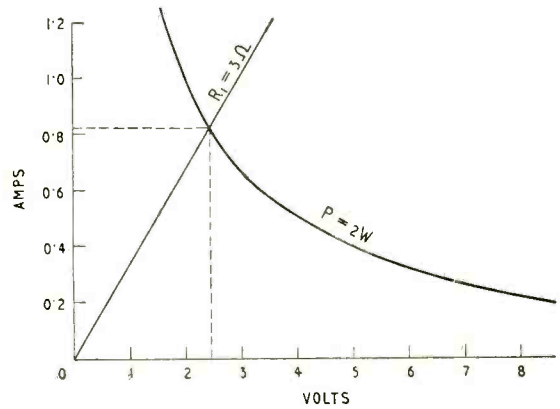

Fig. 3. The top right-hand corners of all the rectangles representing a given power (2 watts in this case) trace out a curve like this.

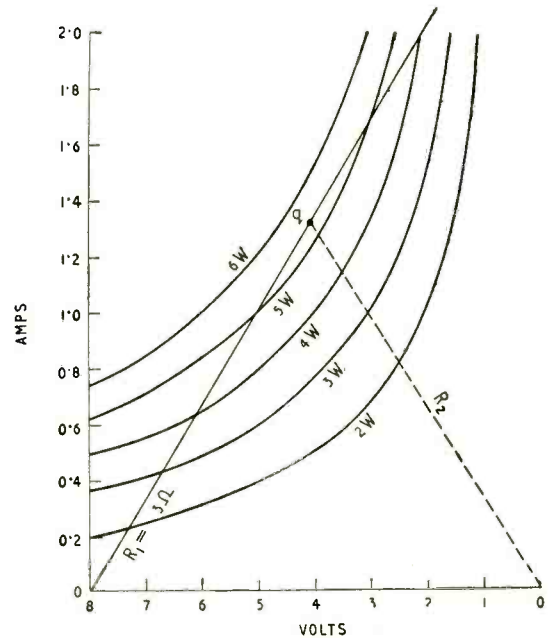

Fig. 4. Power curves can be used to find the value of R_2 receiving maximum power in the series circuit.

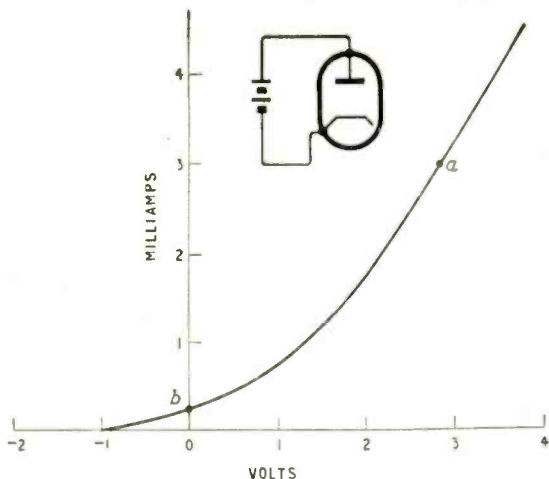

Fig. 5. Graph of a non-linear resistance—that of a diode valve.

drawing a constant-power line. A power of 2W can be made up of 2V, 1A, or 4V, 0.5A, or 5V, 0.4A, or 8V, 0.25A, and any number of such combinations. The 2-W line can be obtained by plotting a few of them and drawing the smoothest curve through the points, as in Fig. 3. This fixes a point on R_1 , through which the R_2 line can be drawn to the applied voltage mark on the voltage scale as before, and the value of R_2 follows. Alternatively, if R_2 is known, a line of the corresponding slope is drawn through the R_1 -P intersection, and where it crosses the $I=0$ axis it indicates the total voltage that has to be used.

A rather more difficult problem would be: Given R_1 and the total voltage, find the value of R_2 in which maximum power is developed. One way of doing this is to draw several different power curves for R_2 . This means that they have to be drawn with reference to the "volts across R_2 " scale, as in Fig. 4. The point on the R_1 line corresponding to the highest power is q , somewhere between 5 and 6 watts (actually $5\frac{1}{2}$), and if the diagram has been drawn well enough it will tell us that R_2 for this condition is 3Ω . As we probably knew all the time, it would invariably be equal to R_1 , whatever that was, because a well-known and important circuit theorem says so (the Maximum Power or Load Matching theorem).

Diode Characteristic

I should think that's about enough for linear resistances, for all the problems so far (except possibly the last) can be solved more easily and neatly without graphs. A diode valve is a simple example of non-linear resistance. As Fig. 5 shows, regarded as a resistor it has several features not according to Ohm. First, a negative voltage does not cause a negative current; i.e., one in the opposite direction to that which flows with a positive voltage. (This is not strictly true, but one has to have a very super-sensitive microammeter to discover it.) On the contrary, the current when the negative voltage is small is positive. Next, the slope of the line (which is visually, as well as mathematically, a curve) increases as the voltage increases positively, which means that the resistance decreases. Near zero it decreases very rapidly from

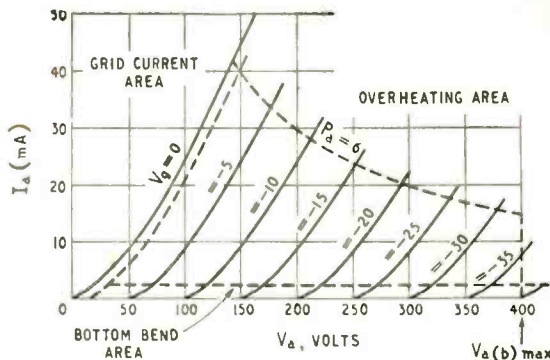

Fig. 6. Typical set of anode-current/anode-voltage curves for a small power triode, showing the areas that for various reasons are out of bounds.

infinity, but at higher voltages than shown here it is practically linear and therefore constant.

This is where the new boy may get confused. The ordinary "d.c." way of reckoning resistance is the ratio of applied voltage to current flowing. At point a , the voltage is 2.8 and the current 3mA, so the resistance is $2.8/0.003=930\Omega$. This resistance is equal to that represented by a straight line joining a to 0. It is not equal to the resistance represented by the slope of the valve curve at a . This slope resistance is sometimes called the a.c. resistance, being the resistance to small alternating currents superimposed on the steady 3mA at a . The reason they are supposed to be small is that the bit of curve involved by them should then be as near straight as makes no matter. Both these kinds of resistance are significant; the d.c. kind when considering the "working point" of a valve (anode voltage, bias, and so forth), and the a.c. kind when considering signals being handled by it. At a there is not a great deal of difference between them, but at b the d.c. resistance is zero, whereas the a.c. resistance is far greater than at a .

A diode is normally used as a rectifier, and rectifiers are always more difficult than you think, so despite the apparent simplicity of the diode I am going to hurry past it to the triode. The anode current in a triode depends simultaneously on two voltages—anode and grid—so really needs a three-dimensional diagram, for the making of which one would have to employ a sculptor, and the Editor would object to the expense. So, although a triode's current/voltage characteristic is really a 3D surface, for economy and convenience it is usual to make do with a series of cross-sections of this surface in two dimensions. Which two depends on what one wants to show most clearly. Sometimes they are anode current (I_a) and grid voltage (V_g), at a number of evenly-spaced values of anode voltage (V_a); and sometimes I_a and V_a at values of V_g . The latter (Fig. 6) are the more generally useful.

Forbidden Areas

The shape of the I_a/V_a curves is very like the diode one. The effect of making the grid negative is, roughly, to push the curve bodily along to the right. What the effect of making the grid positive is, one does not usually bother to find out for ordinary receiving valves, because grid current flows and greatly complicates the

situation, as well as spoiling the valve for most of its uses. So the whole of the area to the left of the " $V_g=0$ " curve is reckoned as out of bounds. In fact, as Fig. 5 shows (for the grid and cathode of a triode together equal a diode) the forbidden area may have to extend to $V_g=-1V$, or even a little farther, to make sure that no appreciable grid current flows.

Next, again assuming that distortionless amplification is wanted, it is advisable to fence off the sharply curved part at the foot of the diagram, marked "Bottom Bend Area." The remaining parts of the curves are not dead straight, but are tolerably so, and can be made much straighter by negative feedback, as we saw last month.

The ceiling is imposed by the valve makers' "maximum anode dissipation"—the maximum power, $V_a \times I_a$, that it is safe to inflict on the anode. Suppose in this case it is 6 watts. Then we draw a 6W curve on the diagram as shown, to rule off what can be called the Overheating Area.

Lastly, the valve maker usually specifies a maximum anode supply voltage ($V_{a(b)max}$). This must not be confused with the maximum anode working voltage ($V_{a,max}$) which is the voltage between anode and cathode when no signal is coming through, or the average when it is. When there is a resistance coupling, this anode voltage is less than the supply voltage—by the amount dropped in the resistance. But it is a voltage that is liable to get at the anode occasionally, at signal peaks or while the cathode is heating up. A vertical line should be drawn at this voltage (say 400 for example) to close up the remaining gap in the boundary.

Power into the Load

We now have a clearly defined area in which to play. But we should remember that there may be a section of it on the right that is only allowed for transient occupation—not for lingering in. That is, if there is a $V_{a,max}$ lower than the $V_{a(b)max}$. On the other hand, momentary trespassing across the "overheating" boundary is permitted, so long as the working point itself is not outside.

If we were aiming at the maximum power output from this valve we would put the working point actually on the 6W boundary at $V_{a,max}$, which (let

us say) is 250V. And if the load were to be a resistance, fed from the maximum supply voltage (400) it would be represented by the sloping line through O and 400V 0mA, as in Fig. 7. From its slope we find it is $6,250\Omega$. We note that the working point is on the " $V_g=-15$ " curve, so that is the grid bias. And if we allow the signal input to swing the grid right up to 0 and down to -30 , the load line shows that the corresponding V_a swing is between 140 and 350 (= 210 peak-to-peak) and I_a is 41.6 and 8 (= 33.6 peak-to-peak). The voltage amplification is therefore $210/30=7$. The power output (into the resistance) is equal to the r.m.s. signal voltage multiplied by the r.m.s. signal current, and since an r.m.s. value is $1/\sqrt{2}$ times a peak value, which in turn is half the peak-to-peak value, this power is equal to peak-to-peak $V_a \times I_a$, divided twice by $2\sqrt{2}$, that is to say by 8. So it is $(210 \times 0.0336)/8=0.88W$.

Voltage Amplification Line

From a practical point of view all this is rather absurd. Is it voltage amplification or power output we are trying to get? We have adopted a usual method for voltage amplification—a resistance coupling—but the valve is clearly unsuitable for this and is intended for power amplification. However, what we are really out for just now is a quick understanding of graphical technique for valves, and I hope I haven't confused you by explaining two things at once. The procedure just described, if applied to a suitable high- μ valve, is correct for *voltage* amplification. One would not actually bother about a maximum power curve, however; the aim would be to slope the line as little as possible, even perhaps into the bottom-bend area, so long as the resistance was not so high as to be shunted too much by stray capacitance at the top signal frequency. The working point would be fixed where it gave equal positive and negative grid swings within reasonable limits of distortion.

For a power amplifier, on the other hand, one wants to get the power out into some external load, such as a loudspeaker, not waste it all in a resistance coupling. The coupling is done by a transformer, which has very little—perhaps negligible—d.c. resistance, but considerable signal-frequency resistance. The usual procedure would be to place the working point as already done in Fig. 7, and then draw from it to the voltage scale a line representing the d.c. resistance of the transformer or choke coupling. Being such a low resistance, the line would be almost vertical, and the resulting $V_{a(b)}$ indicated by where it cut the V_a scale would be only slightly more than the working V_a .

The a.c. load line need not touch the V_a scale at any particular point such as $V_{a(b)max}$; it should be swung round O as a pivot until it indicates the maximum output. The output power is represented by one-eighth of the area of the rectangle of which the load line is a diagonal. If the load line slopes too little, this rectangle is too flat to have much area; if the line slopes too steeply the rectangle is too narrow. The length of the load line diagonal must be equal in both directions from its pivot at O, and must not go beyond the grid-current or bottom-bend boundaries. The $6,250\Omega$ line in Fig. 7 is unlikely to give the largest area because an input signal limited at its positive peak by grid current leaves quite a lot of useful space between its negative peak and the bend boundary. A more promising line would be steeper, indicating a lower load resistance; drawn, in fact, from the point

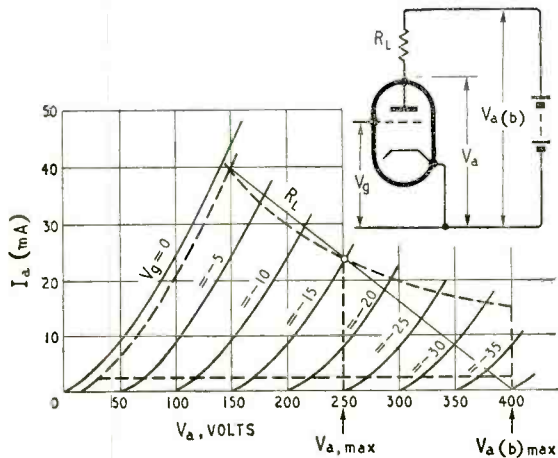

Fig. 7. The Fig. 6 curve sheet with load line added, through the working point (encircled).

where " $V_g = -30$ " cuts the bottom-bend boundary.

In practical design there is vastly more to it than this; all I have been attempting to do is show what the various lines and things on this kind of diagram mean, and how it is that they mean them. If I have succeeded in making this clear, then perhaps you would like to turn back to last month's treatise and note how the ordinary valve curves can be used to derive another set of much straighter curves that represent the behaviour of a valve combined with

negative feedback. Then, of course, there are pentodes. Their curves have quite different shapes, but except in detail the methods are the same.

At least one whole book* has been written on the subject, and the uses included in the *Radio Designer's Handbook* would almost make another book. So there is plenty of scope for follow-up.

* *Graphical Constructions for Vacuum Tube Circuits*, by A. Preisman. (McGraw Hill.)

Manufacturers' Products: NEW EQUIPMENT AND ACCESSORIES

Ground-to-Air Transmitter

A NEW v.h.f. transmitter for ground-to-air communications, rated at 20 W output, has recently been introduced by Ekco Electronics to replace an earlier model. The new set, Type CE91, can be operated on any crystal-controlled spot frequency in the band 100 to 156 Mc/s, channel changing being effected by fitting the appropriate crystal and realigning the circuits. All the controls are readily accessible from the front panel but protected against accidental misalignment by easily removable cover plates.



New Ekco ground-to-air v.h.f. transmitter, Type CE91.

Particular attention has been given to the suppression of spurious emission, a matter of some importance now that the 200-Mc/s band is likely to become a highly populated one before long. The inclusion of bandpass and lowpass filters in the circuit contribute, no doubt, to the "clean" performance claimed for this transmitter.

The set, including the power supply, weighs 75 lb and fits into the standard 19-in rack. It is made by Ekco Electronics, Ltd., Southend-on-Sea, Essex.

Ferrite Rod Aerials

TWO directional rod aerials are now available from the Teletron Co., Ltd., 266, Nightingale Lane, London, N.9.

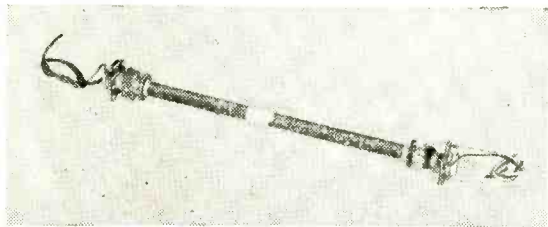

"Teletron" Type FRD ferrite rod aerial.

In Type FRM, which is 4in long, a single wave-wound coil at one end, of 165 μ H inductance, covers 180-550 metres when tuned by a 500-pF variable condenser. The Q at 1Mc/s is stated to be 205.

Type FRD has an additional winding at the other end of the rod giving a combined inductance of 2.2 mH to cover wavelengths up to 2000 metres. The length of this rod is 8in.

Rubber grommets are provided for mounting, and a fibre disc, secured to each coil former, facilitates adjustment when moving the coil on the "Ferrocube" rod core.

The price of Type FRM is 8s 9d and of Type FRD 12s 9d.

Commercial Literature

Marine V.H.F. Radiotelephones, a range of six models giving 10 watts output and covering 40-185 Mc/s with 10 or 20 channels. Available for a.m., f.m. or combined a.m./f.m. Brochure from Redifon, Broomhill Road, London, S.W.18.

Soldering Irons by Hydrel of Switzerland with pointed or hammer-shaped copper bits claimed to withstand oxidation. Elements from 45 to 500 watts, lengths 12½in to 17½in, weights 7 oz to 2½ lb. Leaflet from the sole distributors, A. B. Hobbs & Co., 214, Hatfield Road, St. Albans, Herts.

Overtone Quartz Crystals, 17 Mc/s to 36 Mc/s, listed in a new easy-reference catalogue of Salford crystals from the General Electric Co., Magnet House, Kingsway, London, W.C.2. Also a booklet on selenium rectifiers, giving performance figures and curves for various circuits, and a leaflet on Gecalloy micropowder permanent magnets.

Waveguide Components and test instruments for centimetre and millimetre waves, with notes on automatic measuring instruments suitable for production testing. Illustrated catalogue from Elliott Brothers (London), Century Works, Lewisham, London, S.E.13.

High-voltage Control Valve, triode Type TV501. With 70 kV on the anode, the anode current (max. 1.5 A) can be cut off to 100 μ A by application of -400 V to the grid. Details and characteristics in a brochure from Solus Electronic Tubes, 15-18, Clipstone Street, London, W.1.

Microwave Frequency Meter, 2,400 to 10,200 Mc/s, and other waveguide components and test instruments described in an illustrated catalogue from the Narda Corporation, 66, Main Street, Mineola, N.Y., U.S.A.

Selenium Rectifier Stacks for domestic sound and television receivers. A booklet with information on ratings, coding and polarity markings, dimensions, weights, and 45 pages of performance curves. From Standard Telephones and Cables, Rectifier Division, Edinburgh Way, Harlow, Essex.

Radio Control of Models. Ex-Government equipment for this and other purposes listed in a new mail order catalogue (No. 12) from Arthur Sallis Radio Control, 93, North Road, Brighton, Sussex; price 1s 6d including postage.

Mobile Television Units in motor vans for outside broadcasting, with cameras, control equipment, centimetre-wave transmitters, etc. Diagrams and photographs showing facilities available in a booklet from Marconi's Wireless Telegraph Company, Marconi House, Chelmsford, Essex.

U.H.F. Television Broadcasting

*Study of Propagation Conditions : Geographical Separation of Stations Using Common Frequencies**

THE advance of broadcasting (sound and television) services to increasingly higher frequencies has given rise to a need to understand in considerable detail the manner in which radio waves at the frequencies in question are propagated over the ground in urban and rural areas and through the lower atmosphere. The subject is of both national and international interest and has two distinct aspects so far as the station design and planning engineer is concerned. In the first instance, since the bands allocated for broadcasting purposes have to be shared between the various national operating administrations, it is essential to understand under what conditions and at what geographical separation two transmitters may operate on the same frequency without their broadcast services suffering intolerable mutual interference. Information designed to assist in this matter has been incorporated in curves published by the International Radio Consultative Committee (C.C.I.R.) following the Plenary Assembly held in London in 1953¹. These curves show the field strength likely to be exceeded for 1% and 10% of the time at distances between 100 and 700 km (60 and 430 miles) from a transmitter radiating one kilowatt on frequencies between 30 and 200 Mc/s.

The second aspect of the wave propagation problem concerns the determination of the area around a transmitter (usually much less than 100 km radius), over which the field strength received is sufficient to provide a satisfactory service. In this case, it is the nature of the terrain over which the radio waves travel that determines the received field strength, and there are frequently marked differences observed between a relatively open rural area and the built-up area conditions encountered in large towns.

In a recent contribution², one of the present authors (J. A. S.) has considered the effect of irregular terrain with the aid of the results of an experimental field-strength survey conducted on frequencies in the region of 100 and 600 Mc/s respectively and out to distances of 100 km (60 miles). The present paper is intended to carry the subject a stage further by considering more closely the possibilities of the ultra high frequencies (u.h.f.) for broadcasting purposes with special reference to television transmissions in Bands IV and V (470 to 585 and 610 to 960 Mc/s respectively).

Although the characteristics of propagation at frequencies above a few hundred megacycles per second, and particularly in densely built-up areas, are not yet completely understood, such evidence as exists from American and British field-strength surveys³⁻¹⁰ suggests that it will be possible to serve adequately a relatively restricted area, for example, a large city

and its suburbs, with a transmitter operating at an ultra high frequency. It is already appreciated that a single u.h.f. transmitter cannot serve as large an area as a broadcasting or television transmitter in the v.h.f. bands†, bearing in mind the radio frequency powers and aerial gains it may be feasible to use in the two frequency ranges. We shall, therefore, discuss some points which should be borne in mind when comparing the relative usefulness of u.h.f. and v.h.f. for television transmissions.

Power of Transmitters.—The effective radiated power (e.r.p.) at present available in Band I (41 to 68 Mc/s) is of the order of 100 kW, and the greatest e.r.p. envisaged in the immediate future for this band is about 500 kW. It is possible that effective powers of a similar magnitude may ultimately be achieved for Band III (174 to 216 Mc/s).

The order of actual radio frequency power likely to be obtained in Bands IV and V is somewhat uncertain, but a value in the region of 10 to 50 kW seems reasonable for the next few years; and the prospects of a further increase are not out of the question. The degree of aerial gain and directivity it may be practicable to use in Bands IV and V will depend to some extent upon the nature of the area to be covered, and whether the transmitter is located centrally or to one side of the area; greater gain and directivity should be possible in the latter case, and a gain of, say, 20 db—giving a possible e.r.p. of 1,000 to 5,000 kW—might not be unreasonable. It is already envisaged by the U.S. Federal Communications Commission that the e.r.p.s to be used in Bands IV and V in the U.S.A. will be ten times those permitted in Band I.

Sensitivity of Receivers.—At present the overall noise factors (including average effects of cosmic noise) of u.h.f. receivers are 6 db or more worse than those of v.h.f. receivers; it is probable that future progress may lead to a reduction in this difference. In this connection, electrical interference, and in particular that arising from ignition systems, sometimes limits the range of satisfactory reception; but such interference is likely to be less serious at the higher frequencies.

Wave Polarization.—Whilst vertical polarization may offer some advantages over horizontal polarization in Band I (for example in the field strength obtained in fringe areas and in shadows) there would appear to be little to choose between the two polarizations for

* Official communication from D.S.I.R. Radio Research Station, Slough.

† The V.H.F. band extends from 30 to 300 Mc/s and therefore includes broadcasting Bands I, II and III.

By R. L. SMITH-ROSE,

C.B.E., D.Sc., Ph.D., M.I.E.E.,

and

J. A. SAXTON,

D.Sc., Ph.D., M.I.E.E.

Bands III, IV and V (and particularly IV and V) from the point of view of the field strength provided generally within the service area. It is possible, however, that considerations of aerial design (both transmitting and receiving) may lead to a preference for one kind of polarization. For instance, a high-gain transmitting aerial (with omnidirectional characteristics in azimuth) using horizontal polarization can conveniently be obtained with a cylindrical array of vertical slots.

Field Characteristics.—It has been demonstrated that, for typical urban and rural areas of the kind found in the midland and southern regions of England and the eastern seaboard of the U.S.A., the median field strength (i.e., that exceeded for 50 per cent of receiving locations) is, to a first approximation, independent of frequency over Bands I to V for a given radiated power. The variation about the median value varies with frequency, however, and in Bands IV and V the field strength exceeded at 90 per cent of receiving locations may be some 5 to 10 db less than the corresponding value in Band I. These fields obtain in general where there is not a clear line of sight from the transmitting to the receiving aerial. When direct inter-visibility is possible it may be that at times a field strength approaching the free-space value will occur, although it is also possible that, even in the range of inter-visibility, multi-path transmission may produce interference effects giving very low field strengths. Such effects may occur more frequently in Bands IV and V than in Band I. In practice, however, it is likely that some diffracting obstacles—buildings or trees—will intervene between the transmitter and receiver, under which conditions the statistical distribution of field strength will be as indicated above. The experimental surveys^{8, 9} also show that the median field strength at u.h.f. in densely built-up areas may be at least 10 db less than the overall median for an area embracing both urban and rural conditions: a similar effect, though less pronounced, exists in Band I.

Diffraction Effects.—An important factor in comparing the coverage to be obtained at v.h.f. and u.h.f. is the intensity of the shadows cast by diffracting obstacles. The general effects of such diffraction, often occurring repeatedly over a given transmission path, are embraced by the statistical evaluation of field strength described above. A more direct comparison of diffraction effects at various frequencies can, however, be made when a single obstacle is involved. At the frequencies in question it is a reasonable approximation to estimate such shadow effects from the principles of Fresnel diffraction theory.^{11, 12} On this basis it can be shown that, when the diffraction loss is appreciable, the ratio of the field in the shadow to the undisturbed field above the obstacle is inversely proportional to the square root of the frequency. Thus in going from 50 to 500 Mc/s the field at a point in the shadow behind an opaque diffracting obstacle will be 10 db less at the higher than at the lower frequency for the same field immediately above the obstacle.

Attenuation Effects.—Although the experimental evidence is perhaps somewhat scanty, there is little doubt that as the frequency increases through the v.h.f. and u.h.f. bands the attenuation of waves passing through buildings and trees increases; and it is not unreasonable to assume that any substantial brick building is opaque for frequencies exceeding about 100 Mc/s, and almost certainly so for frequencies in

Bands IV and V, under which conditions any signal received behind such a building is due to diffraction over and round it.

The attenuation of Band I transmissions in passing through wooded areas is not very great: the order of attenuation in a thick, continuous wood is about 0.03 db/metre, and there is evidence that greater attenuation occurs with vertically than with horizontally polarized waves—typical figures being 0.04 db/m as compared with 0.02 db/m. In Band III, the attenuation through woods may amount to 0.07 db/m; whilst in Bands IV and V values of 0.2 to 0.3 db/m may be reached. At u.h.f. there is less dependence upon wave polarization than at lower frequencies. Trees in leaf, and particularly when wet, produce more attenuation than when leafless and dry.

Field Complexity and Performance of Receiving Aerials.—On any receiving site, where the field may be influenced by diffraction and reflection at local obstacles, large fluctuations in field strength can occur over distances comparable with the wavelength: this is true at both v.h.f. and u.h.f.^{9, 13} The actual spatial variations are thus more rapid in Bands IV and V than in Band I, and a range of variation of at least 20 db will not be uncommon on a typical receiving site.

It may well be that in some locations it would appear desirable if possible to achieve a gain of 10 db or more with a receiving aerial, but the performance of a directive aerial in fields of the complexity likely to arise in practice is not yet known, and it is possible that the gain to be expected in a uniform field will not be realized. It has in fact been suggested⁴ that, if the energy at a given point arrives predominantly after scattering from numerous obstacles within a certain zone near to the receiving aerial, the input signal to the receiver may be more if a non-directive rather than a highly directive aerial is used. This, however, is a portion of the subject requiring much more investigation.

The Use of High-Gain Transmitting Aerials.—If a transmitting aerial is designed to have a gain of 20 db, and to radiate uniformly in a horizontal plane, the beam width in the vertical direction will be quite small—not more than 1 or 2 degrees—and, as a result, receiving locations near to the transmitter, i.e., up to a few kilometres if the transmitting aerial is at, say, 200 metres above ground level, may suffer from a "skip" effect. It has been shown⁶ that, with an aerial having a gain of about 20 db (at 850 Mc/s), when the beam was tilted down from the horizontal position by 1.3 degrees, an increase of 11 db in the median field strength was obtained for distances of 1 to 8 km. Thus if very directive transmitting aerials are to be used the advantages of tilting the radiated beam downwards, either by electrical or mechanical means, should be borne in mind: in fact such tilting will be necessary if the full value of the aerial gain is to be realized. For serving a limited area it might be better to locate the transmitter outside the area rather than centrally; it would not then be necessary to provide all-round horizontal coverage, and the required degree of gain could be achieved with a greater beam width in the vertical plane.

Statistical Assessment of Relative Coverage at U.H.F. and V.H.F.—With so many variable factors to contend with, and the limited amount of knowledge so far available, it is not easy to give an assessment of the absolute performance of a u.h.f. system, but a comparison of what may be expected at u.h.f.

and v.h.f. may be attempted. For this purpose, and by way of example, we may compare the ranges at which equivalent services (i.e., the same signal-to-noise ratios, S/N) can be provided at frequencies of 50 and 500 Mc/s.

Let it be assumed that the overall noise factor of a receiver at 500 Mc/s is 6 db worse than one at 50 Mc/s (although future improvements in this figure might be expected), and that any difference in feeder loss at the receiving station for the two frequencies may be ignored.

In the first place we know¹⁰ that the median field strength (at 50 per cent of locations) at a given distance for a mixed urban and rural type of terrain is approximately independent of frequency for constant e.r.p.; so that for identical aerials (e.g., half-wavelength dipoles) the input voltage to the receiver at 500 Mc/s is 20 db below that at 50 Mc/s, and the S/N ratio is therefore 26 db worse. Suppose that at

500 Mc/s a receiving aerial gain of 10 db is achieved, and that an average gain of 2 db is allowed for aerials used at 50 Mc/s; it will then be seen that at a given distance (for constant e.r.p.) the S/N ratio is 18 db worse at the higher than at the lower frequency. From this it may be deduced¹⁰ that ranges† of 60 and 30 km at 50 Mc/s will be reduced to 30 and 12 km respectively at 500 Mc/s, the e.r.p. being the same at the two frequencies. If a predominantly urban area is to be served, these latter ranges will be reduced to 25 and 10 km because the median field strength at 500 Mc/s in densely built-up areas may be 10 db below the overall median as opposed to only 4 db at 50 Mc/s.

Now consider the situation if the e.r.p. at 500 Mc/s is ten times that at 50 Mc/s and if the field strength

† At these ranges, median field strengths of about 2 and 10 mV/m respectively are obtained from a transmitter of 100 kW, e.r.p.

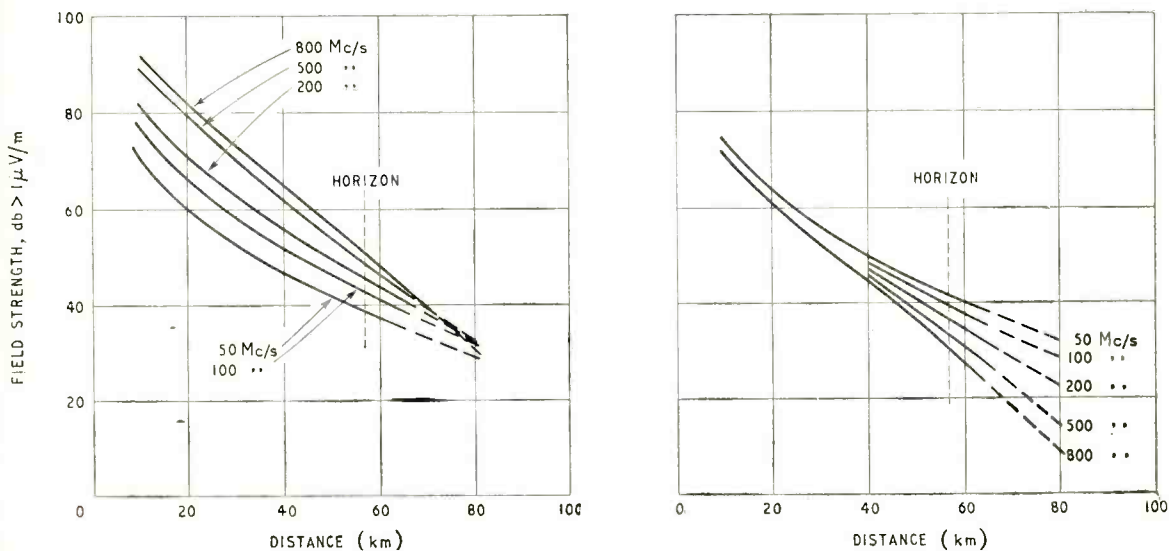

Fig. 1. Field strengths for frequencies between 50 and 800 Mc/s; (a) over smooth ground, (b) over irregular terrain. Effective transmitted power 1 kW, transmitter aerial height 300ft, receiver aerial 30ft approx. (Courtesy Proc. I.E.E.)

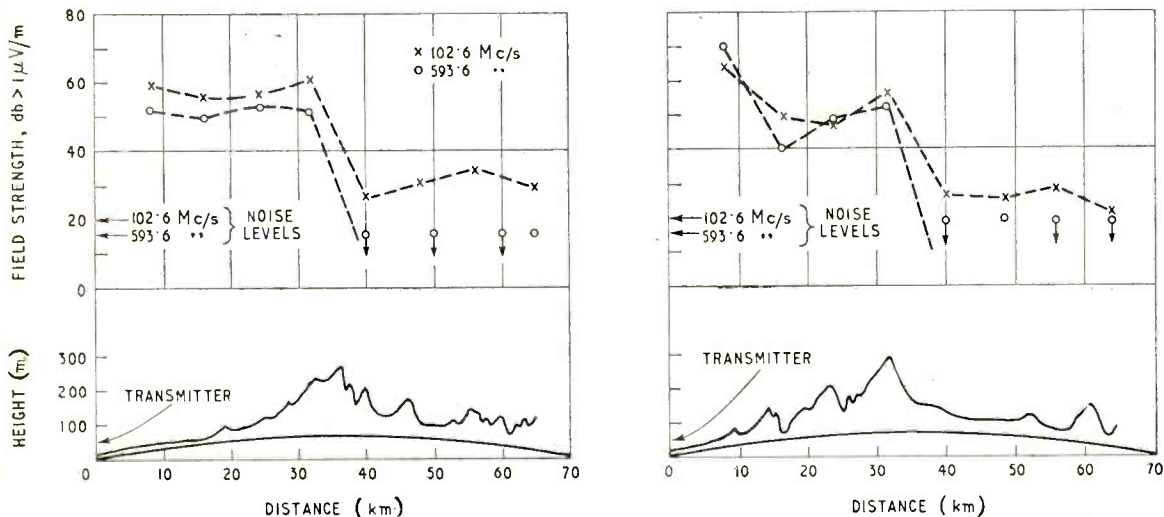

Fig. 2. Effect of ground contour on received field strength. Two different paths are shown. Effective radiated power 1 kW. (Courtesy Proc. I.E.E.)

exceeded at 90 per cent of receiving locations is used as the basis for comparison. In this case the field strength at 500 Mc/s will be of the order of 5 db more than at 50 Mc/s,¹⁰ and, following the argument given above, the S/N ratio at a given distance will be 13 db worse at the higher than at the lower frequency. From this it would appear that ranges of 60 and 30 km at 50 Mc/s will be reduced to 36 and 18 km respectively at 500 Mc/s in the general case, and to about 30 and 12 km in built-up areas. The corresponding ranges in Band III (about 200 Mc/s) will be intermediate between those referred to above for Bands I (50 Mc/s) and IV (500 Mc/s); whereas near the top of Band V (about 900 Mc/s) the ranges will perhaps be three-quarters of those attainable in Band IV.

Conclusions.—The results described above are summarized in Tables I and II from which the estimated ranges to be expected for the various conditions assumed can be clearly seen.

TABLE I

Comparative ranges in Bands I and IV for equal e.r.p. and based on median field strengths.

(Noise factor for receiver 6 db worse in IV than in I)

Frequency Mc/s	Conditions	Range in km	
		1*	2†
50	Mixed urban and rural	30	60
500	Mixed urban and rural	12	30
500	Mainly urban	10	25

TABLE II

Comparative ranges in Bands I and IV with e.r.p. in IV ten times that in I, and based on field strengths exceeded at 90% of receiving locations.

(Noise factor for receiver 6 db worse in IV than in I)

Frequency Mc/s	Conditions	Range in km	
		1*	2†
50	Mixed urban and rural	30	60
500	Mixed urban and rural	18	36
500	Mainly urban	12	30

* Range 1 corresponds to field strength of 10 mV/m in Band I.

† Range 2 corresponds to field strength of 2 mV/m in Band I.

While examples of this type could be multiplied, their usefulness is rather limited in the absence of much more experimental evidence. More knowledge is required at ultra high frequencies concerning the nature and complexity of the field at typical receiving locations, and the performance of directive receiving aerials in such fields. Especially in densely built-up residential areas is there a need for an experimental investigation of the receiving conditions where both the height and small changes in position of the receiving aerial may have a marked influence on the results obtained in television reception.

The substance of this paper was presented by the United Kingdom delegation at a meeting of C.C.I.R. Study Group XI (Television) held in Brussels in March/April, 1955, and it is to be expected that the resultant international discussion may stimulate

further research in this subject in different countries.

The work described above was carried out as part of the programme of the Radio Research Board of the Department of Scientific and Industrial Research.

REFERENCES

- ¹ C.C.I.R. Documents of the VIIth Plenary Assembly, London, 1953, Vol. I, p. 141.
- ² Saxton, J. A. "Television Coverage," *Wireless World*, 1954, 60, p. 173.
- ³ Brown, G. H., Epstein, J., and Peterson, D. W. "Comparative Propagation Measurements; Television Transmitters at 67.25, 288, 510 and 910 Mc/s," *R.C.A. Review*, 1948, 9, p. 177.
- ⁴ Brown, G. H. "Field Test of Ultra-High-Frequency Television in the Washington Area," *ibid.*, p. 565.
- ⁵ Fisher, J. "Field Test of U.H.F. Television," *Electronics*, Sept., 1949, 22, p. 106.
- ⁶ Epstein, J. "Broadcasting TV in the U.H.F. Band," *Electronics*, Nov. 1952, 25, p. 102.
- ⁷ Guy, R. F. "Investigation of Ultra-High-Frequency Television Transmission and Reception in the Bridgeport, Connecticut, Area," *R.C.A. Review*, 1951, 12, p. 98.
- ⁸ Epstein, J., and Peterson, D. W. "An Experimental Study of Wave Propagation at 850 Mc/s," *Proc. I.R.E.*, 1953, 41, p. 595.
- ⁹ Saxton, J. A., and Harden, B.N. "Ground Wave Field-Strength Surveys at 100 and 600 Mc/s," *Proc. I.E.E.*, 1954, 101, Part III, p. 215.
- ¹⁰ Saxton, J. A. "Basic Ground-Wave Propagation Characteristics in the Frequency Band 50-800 Mc/s," *ibid.*, p. 211.
- ¹¹ Megaw, E. C. S. "Some Effects of Obstacles on the Propagation of Very Short Radio Waves," *Jour. I.E.E.*, 1948, 95, Part III, p. 97.
- ¹² McPetrie, J. S., and Ford, L. H. "Some Experiments on the Propagation of 9.2 cm Wavelength, especially on the Effect of Obstacles," *Jour. I.E.E.*, 1946, 93, Part IIIA, p. 531.
- ¹³ Kirke, H. L., Rowden, R. A., and Ross, G.I. "A V.H.F. Field-Strength Survey on 90 Mc/s," *Proc. I.E.E.*, 1951, 98, Part III, p. 343.

"WIDE-RANGE ELECTROSTATIC LOUDSPEAKERS"

THE third instalment of this article, which began in the May issue, is unavoidably held over. In the meantime it should be pointed out that in Part 2 (June issue) the last sentence of the second paragraph (p. 265) should read: "In practice the compliance will be considerably less than the electrical negative compliance. . . ."

Line 23, left-hand column, p. 266, should read "velocity of motion will vary *inversely* with frequency"; and in line 2, right-hand column, p. 267, " f_2 " should be " f^2 ".

RETAIL RECEIVER SALES

THE "seasonal decline" in the sales of domestic receiving equipment is shown in this table from a retail market survey for the first four months of the year issued by the British Radio Equipment Manufacturers' Association. Fifty-five per cent of all the sales in April were credit transactions.

	Sound	Radiograms	Television
January	98,000	35,000	103,000
February	99,000	33,000	98,000
March	95,000	24,000	85,000
April	79,000	13,000	71,000

FM/AM Tuner

Eddystone Model 820 Embodying a Foster-Seeley Discriminator

WITH so many f.m. tuner units and receivers having almost standardized circuitry it is refreshing to encounter one that is in any way different. The Eddystone Model 820 tuner can perhaps claim this distinction on two counts. In the first case it has a Foster-Seeley discriminator, and secondly it provides the choice of two pre-selected stations in the medium waveband and one in the long. A further distinction is that provision is made also for feeding-in a gramophone output, although there is no actual audio amplification provided.

All three forms of entertainment, f.m. and a.m. broadcasting and records are selected by a single five-position switch.

The tuner has exceptionally high sensitivity and is capable of giving a very satisfactory performance outside the normal service area of a v.h.f. broadcast station.

Following accepted practice the "820" has an r.f. amplifier and all the three associated r.f. circuits, aerial, inter-valve coupling and oscillator, are tuned by a tiny three-gang capacitor designed especially for this unit. It is fitted with a single glass ball-bearing at the rear end of the rotor shaft and this novel innovation has been adopted in order to eliminate loop couplings in the capacitor.

The r.f. valve, (V1), is a 6AM6 r.f. pentode choke-capacitance coupled to the tuned intervalve circuit and followed by a double-triode 12AT7, (V2), functioning as mixer and local oscillator for f.m. reception. The i.f. output from the mixer, which is at

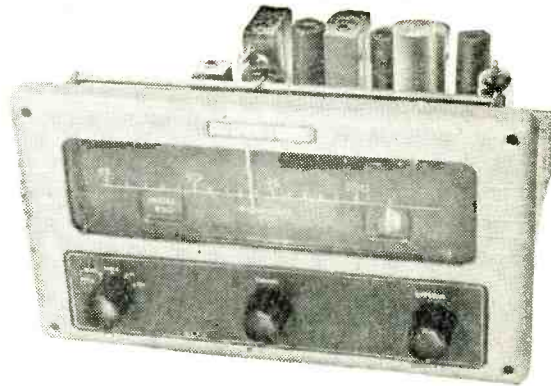

The large scale window with controls below characterizes the Model 820 f.m./a.m. tuner as an Eddystone product.

10.7 Mc/s, is fed *via* the f.m./a.m. switch to the grid of the hexode section in an ECH42, (V3), normal frequency changer. For f.m. reception this section functions as the first i.f. amplifier and its accompanying triode is inoperative.

For a.m. reception the hexode section of the ECH42 becomes the mixer with its triode functioning in the usual way as a local oscillator. For this condition of operation an i.f. of 465 kc/s is employed. I.F. transformers of 10.7 Mc/s and 465 kc/s are connected in series in the anode circuit and automatically select, without switching, the correct i.f. signal according to the mode of operation, e.g., as first i.f. at 10.7 Mc/s or mixer at 465 kc/s. Following the ECH42 is another 6AM6, (V4), functioning as second i.f. on 10.7 Mc/s or first i.f. on 465 kc/s as required.

The 10.7-Mc/s signal passes from V4 to another 6AM6, (V5), which is operated at relatively low anode and screen voltages, and behaves as a limiter. Under working conditions the limiter stage has quite an appreciable amount of grid bias derived from a 0.27-MΩ grid resistor. This negative d.c. voltage is used also to operate an EM80 magic-eye tuning indicator, (V7), on f.m. and supplies an a.g.c. voltage to the input grids of V3 and V4.

The 10.7-Mc/s discriminator transformer is in the anode circuit of the limiter, (V5), and is followed by a double diode 6AL5, (V6), arranged as a typical Foster-Seeley discriminator, its a.f. output going *via* a de-emphasis network and f.m./a.m. switch to an output volume control.

For a.m. reception the i.f. signal stops short at the anode of the 6AM6, (V4), following the ECH42, (V3), and is there rectified by a crystal diode and the audio output taken, *via* the f.m./a.m. switch to the aforementioned output volume control. The d.c. voltage derived from the

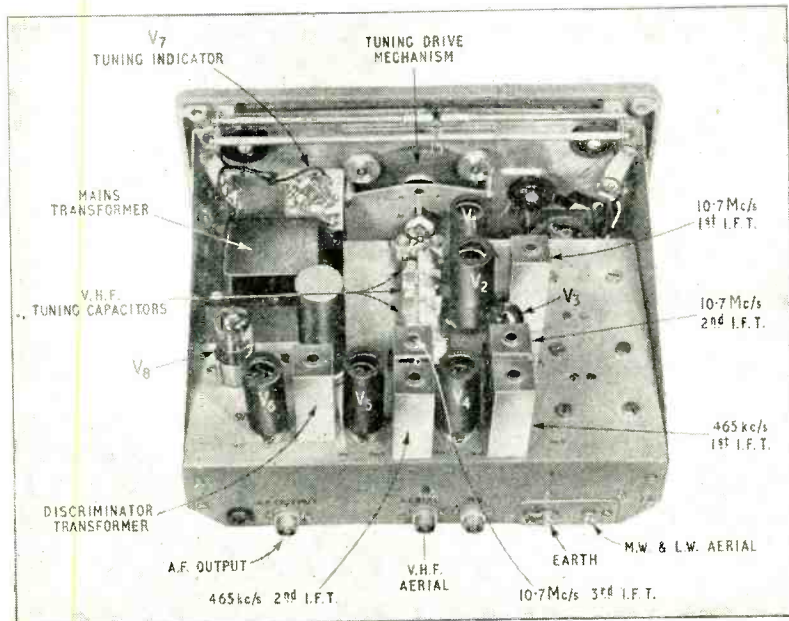

Viewed from the back the positions of the valves, i.f. and mains transformers are clearly seen. Also seen is the tuning mechanism.

crystal current is used for a.g.c. This a.m. grid-bias (or a.g.c. voltage) is not applied to the tuning indicator which is not operative on the pre-set a.m. stations.

The tuner has its own a.c. power supply unit and this comprises a double-wound mains transformer, an EZ41 full-wave h.t. rectifier, (V8), a 500-ohm smoothing resistor and two 32- μ F smoothing capacitors.

A coaxial socket is provided at the back of the unit for a 70-ohm feeder from the v.h.f. aerial and a screw terminal for a random-length aerial for a.m. reception. Two other coaxial sockets are included at the back; one is the a.f. output, the other is for a gramophone input. There is also an earth terminal.

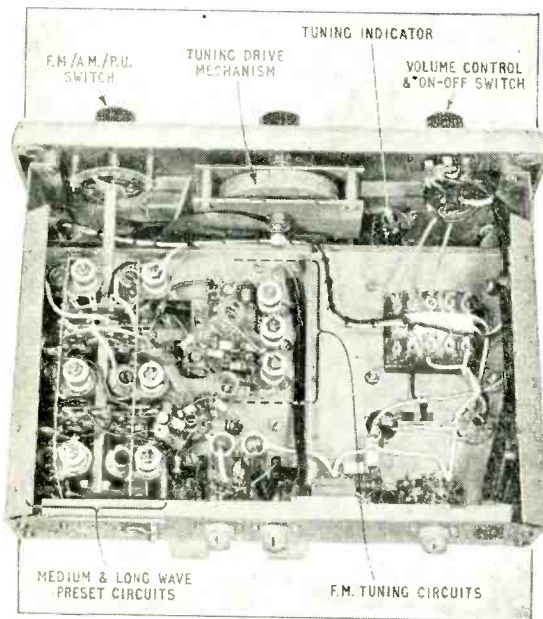

The chassis has a metal base plate which when removed gives access to the tuning circuits, small components and wiring.

In view of the potential high sensitivity of the tuner, tests were carried out at some distance from Wrotham and in a rather poor location from the point of v.h.f. reception on the south coast. As the tuner was designed in Birmingham and reputed to put up a good performance there it was felt this would be a good way of testing its merits.

A further handicap was imposed by using a loft aerial, since no other of the right type was available at the time. It was a single dipole and the direct "line-of-sight" to Wrotham was interrupted by high ground up to 600 to 700ft about 3 miles away. The receiving aerial was just under 200ft above sea level.

The tuner put up a most satisfactory performance, signals being strong enough to give good limiting and entirely suppress the background and all but the most severe interference from passing motor cars.

Aircraft flying in the vicinity of the receiving site are a great nuisance on the v.h.f. bands and while the "820" put up a stout effort in resisting the greater part of the signal flutter they produced it could not cope with the worst kind. So severe can this be at times that it is doubtful if any f.m. receiver would cope with it under all conditions; however, it is possible a better aerial would make a great deal of dif-

ference. Provided the signal is maintained above the limiting level the audio output remains quite steady, despite quite violent "throbbing" of the magic-eye.

Used with a good amplifier and loudspeaker there is a crispness in the reproduction that is rarely possible on other bands owing to the necessity to restrict the receiver's bandwidth in order to keep out interference from stations on nearby wavelengths. Apart from this the most impressive thing about the reception, especially to anyone continuously plagued by whistles, "monkey chatter," and crackles of many kinds, that prevail almost anywhere south of London in the U.K., is the delightfully quiet background.

First impressions may be that not enough de-emphasis is provided, but this will generally prove groundless as greater familiarity is gained with f.m. reception. However, a little tone-correction can generally be applied in the audio amplifier if thought desirable.

The tuning control is delightfully smooth and free of backlash and the "sponginess" sometimes associated with cord drives. Actually the cord drive in the "820" tuner operates the pointer only and the gang capacitor is driven through a combination of spring-loaded gears and friction discs giving an overall reduction of about 76 to 1. A heavy flywheel smooths out any little irregularities in the system.

The tuning scale is just over 6in long and is traversed by a long pendant pointer. It is directly calibrated and covers 85 to 101 Mc/s with points at every megacycle and figures every 5 Mc/s. Viewing is made easy by employing white for figure markings and the pointer and a chocolate-coloured background. The tuning indicator is viewed through a cut-out in the background plate and is enclosed by the scale window. This measures 8½ × 2½ in and takes up the whole of the top half of the front panel. The three controls: AM/FM/PU switch, tuning and volume/on-off, in this order from left to right, are spaced out equidistant below.

The a.m. side of the tuner has been rather ignored so far, but it is well up to the performance of a mixer-i.f.-detector combination. In the MW1 position of the switch any station between 960 and 1,550 kc/s can be set up and in MW2 position the range is 610 to 960 kc/s. The range on long waves is 150 to 250 kc/s.

Since the f.m. side provides the three main programmes, Light, Home and Third, the stations set up on the pre-tuned circuits could with advantage be a regional which sometimes has a programme of local interest, or one's favourite Continental stations.

The tuner is supplied in chassis form as illustrated and measures 11 × 6½ × 8½ in. The front is a sturdy light-alloy casting and forms a rigid support for the chassis which is braced by side members giving good mechanical rigidity; this rigidity is essential for good frequency stability. High praise can be given to the "820" tuner in this respect as the drift from cold to working temperature is comparatively small for v.h.f. equipment, while the long-term stability is very good indeed. After any initial correction has been made—and this is only necessary if the station is tuned-in immediately the set is switched on—no further attention is needed unless one wants another programme.

The tuner is supplied with all necessary fixing screws, coaxial sockets and trimming tools, and the price is £28 10s, plus £9 10s U.K. purchase tax.

The makers are Stratton and Co., Ltd., Eddystone Works, Alvechurch Road, West Heath, Birmingham, 31.



Prize-winning entries in the B.S.R.A. competition. (Right) J. W. Dix's four-channel tape recorder, and (left) S. H. Bryant's mixer unit.

B.S.R.A. AMATEUR COMPETITION

IN the competition for amateur constructors of sound recording and reproducing equipment, held in connection with the British Sound Recording Association's annual exhibition, the President's Trophy and the *Wireless World* prize were won this year by J. W. Dix of Nuneaton with a four-channel tape recorder intended primarily for sound effects in theatrical performances. The tape mechanism is designed to handle $\frac{1}{2}$ -inch as well as standard $\frac{1}{4}$ -inch wide tape at speeds of $7\frac{1}{2}$ or 15 in/sec. Up to four tracks, with individual plug-in pre-amplifiers, can be used for stereophonic effects. In all there are seven heads.

The runner-up was S. H. Bryant, who was awarded the Committee Prize for a 3-way mixer unit.

(A description of new items of commercial equipment for sound reproduction shown at the B.S.R.A. exhibition is included in the report on p. 312 of this issue.)

RADIO TELEARCHICS: Two Recent Applications

On the left is a French Railways electric locomotive and four coaches photographed while travelling under radio control, without driver or passengers, on the main line between Paris and Le Mans. Orders to control the brakes and motors were given verbally by radio telephone from a railcar travelling alongside and were received at a point about half-way along the route. From here control signals were transmitted to the locomotive on 1.9 metres. The

jet fighter aircraft on the right was flying under control of a new precision u.h.f. radio guidance system designed by



the U.S. Air Force and the Sperry Gyroscope Company. This provides for automatic take-off and landing with control of climb, dives, orbiting and other manoeuvres. If the radio carrier is cut off for any reason an automatic control system in the aircraft takes over.



True
to the
TRIX
Tradition

The TRIX tradition of quality has been established by an unswerving allegiance to the highest standards of sound engineering. TRIX Sound Equipment has been developed and produced to give faithful and lasting service anywhere in the world.



Model T41 Home Music Amplifier.
Bass and Treble controls and mains switch on independent control panel. High and low gain inputs. For all types of pick-ups and speakers.
£16 - 10 - 0



Model T.635, 30-watt Amplifier.
Designed for A.C. mains and can also be operated by batteries. This high quality amplifier has inputs for 2 microphones and gramophone. Two tone controls are fitted for bass and treble boost.

The TRIX ELECTRICAL Co. Ltd.
MAPLE PLACE,
TOTTENHAM COURT ROAD,
LONDON, W.1

Tel: MUSEum 5817
Grams: TRIXADIO, WESDO, LONDON

RANDOM RADIATIONS

By "DIALLIST"

Timely Hints

SO work is going ahead—or at any rate on the verge of going ahead—on the I.T.A. Midland station at the quaintly named Hints in Staffordshire. A pity there isn't a suitably situated village called Tips to be the Independent Television centre of some other area! Hints, anyhow, seems well chosen, for it is 500ft above sea-level and in the middle of the thickly peopled midland area bounded by Shrewsbury, Chesterfield, Mansfield, Market Harborough and Gloucester. At the moment of writing I haven't seen a map showing the expected service area. I thought at first sight that the one for the Croydon station was a trifle on the optimistic side. However, even the 1-kilowatt signal from the Belling and Lee test transmitter has been quite well received in not a few places which were expected to be in the fringe areas.

Beyond Expectations

The B.B.C. has always been wise in drawing its expected service area maps very conservatively, for it's far better to give pleasant surprises than to raise false hopes and dash them later. The temporary Norwich transmitter at Tacolneston (pronounced Tackleston, I'm told on the best local authority) is a case in point. I'm writing these notes at a place well outside the predicted service area of the station; but really good and consistent pictures are received here on 3-element yagis consisting of dipole, reflector and director. One sees a few of the 4-element type; but for most homes the smaller array does all that's needed.

Bits and Pieces

IS Kent a specially windy county? I don't know, for until recently I've seldom done more than pass through parts of it on the way to somewhere else. I ask the question because when I was moving about Kent in March and April this year I saw more damaged TV aerials than I've ever noticed anywhere before. Driving one day from Tunbridge Wells to Wrotham one saw all over the place "Hs" which had lost one half of the reflector and "Xs" whose

directors had been injured in the same way. In several cases the lower part of the dipole was missing. I even noticed one whose upper half had gone; somehow, I don't think the owner could be getting a very good picture!

The War of the Bands?

AS I write there are signs of a hard-fought struggle to come over the still unallotted channels in Band III. The I.T.A. had apparently taken it for granted that the whole of Band III would be its own particular stamping ground, when along came the B.B.C. with an order for two pairs of Band III transmitters for delivery in the latter part of next year. One side says that it must have all the eight channels if it is to provide country-wide coverage; the other lays claim to some of them for the development of its second programme. So far, the Postmaster General has "lain low and said nuffin'"; but his decision can't be long delayed if planning is to go ahead. What a pity it is that there aren't enough channels for both the B.B.C. and the I.T.A. to have all they want. With three vision programmes to choose from, there should be

something to suit all tastes at most times and the £3 licence would be a magnificent bargain—if it remains at £3. I wonder whether it's at all possible that with the world-wide spread of television, some widening of Bands I and III may come about by international agreement? If that doesn't happen, it might be a tough problem to satisfy the B.B.C., the I.T.A. and the viewer.

Quarts into Pint Pots

Come to think of it, though, the B.B.C. has already shown in Band I, that wistful geographic separation of transmitters and intelligent choice of horizontal or vertical polarization can do something very like fitting quarts into pint pots. The present plan is for eighteen stations in the five channels of Band I. A dozen or more are already working and (except possibly during certain freak conditions) mutual interference doesn't appear to cause any headaches. For equal aerial heights and output ratings one would expect Band III transmitters to have shorter ranges than those using Band I. Though this means smaller service areas and therefore more stations to cover the whole



"WIRELESS WORLD" PUBLICATIONS

	Net Price	By Post
RADIO LABORATORY HANDBOOK. M. G. Scroggie, B.Sc., M.I.E.E. 6th Edition	25/-	26/3
STUDIO ENGINEERING FOR SOUND BROADCASTING. B.B.C. Engineering Training Manual by members of the B.B.C. Engineering Division. General Editor J. W. Godfrey.	25/-	25/6
SHORT-WAVE RADIO AND THE IONOSPHERE. T. W. Bennington, Engineering Division, B.B.C. Second Edition	10/6	10/10
INTRODUCTION TO VALVES. R. W. Hallows, M. A. (Cantab.), M.I.E.E., and H. K. Milward, B.Sc. (Lond.), A.M.I.E.E.	8/6	8/10
WIRELESS WORLD TELEVISION RECEIVER MODEL II: Complete constructional details with notes on modernizing the original design	3/6	3/9
RADIO INTERFERENCE SUPPRESSION as Applied to Radio and Television Reception. G. L. Stephens, A.M.I.E.E.	10/6	10/11
SOUND RECORDING AND REPRODUCTION. A B.B.C. Engineering Training Manual. J. W. Godfrey and S. W. Amos, B.Sc. (Hons.), A.M.I.E.E.	30/-	30/8
ADVANCED THEORY OF WAVEGUIDES. L. Lewin	30/-	30/7
FOUNDATIONS OF WIRELESS. M. G. Scroggie, B.Sc., M.I.E.E. 5th Edition	12/6	13/-
TELEVISION RECEIVING EQUIPMENT. W. T. Cocking, M.I.E.E. 3rd Edition	18/-	18/8

A complete list of books is available on application.

Obtainable from all leading booksellers or from

ILIFFE & SONS LTD., Dorset House, Stamford Street, London, S.E.1.

country, it should also mean, one would think, that stations using the same frequency could be sited closer together than on Band I without causing interference. If these assumptions are right, it should be possible to fit quite a lot of television stations into the eight channels which will eventually be available in Band III.

F.M. Quality

WITH amplitude modulation volume compression is a necessity. Were it not used, listeners at close quarters to a high-power transmitter would be liable to be deafened by *fortissimo* orchestral passages while others in distant parts might find their loud-speakers silent when a soloist was playing or singing very softly. But it needn't be done to anything like the same extent with f.m., for the transmitter radiates at full power all the time. So long as the signal is sufficient to work his limiter, the distant listener gets all that it has to give and hears the softest passages, and the close-quarter listener has only to adjust his receiver properly in order to ensure against its being overloaded by the loudest. I haven't been able yet to listen to Wrotham since it came into regular service; but in the days when I regularly received its experimental transmissions it seemed that there was much less volume compression than on the medium and long waves. If compression can be used sparingly and lightly with the v.h.f. programmes listeners will be delighted to find wireless music something very much more like the real thing.

An Essential

So far, I haven't had the chance of handling or hearing any of the f.m. receivers that are being manufactured for domestic use. There used to be an idea that f.m. wouldn't suit the man or the woman in the street because very accurate tuning is needed if horrid distortion is to be avoided. When the B.B.C. was making its prolonged tests on the original Wrotham station part of its programme was to discover whether this was true or not. Some entirely non-technical folk were lent receivers and, after being instructed in how to work them, were left to get on with it. They got on very well indeed. The sets were provided with automatic frequency control and I understand that investigations at a later date showed that their users found them no more difficult to handle than their own medium-wave sets

"THE CHOICE OF CRITICS"

FOR over thirty years the HOUSE OF BULGIN has been designing and building radio and electronic components of the highest technical standard and quality, and with the passing years, the name of BULGIN has figured prominently in every new development in the fields of radar, radio, telecommunications, instruments and all branches of electronics. Today, this wealth of experience is incorporated in our wide range of products, which is being continually added to and improved as developments in the fields of electronics advance.

BULGIN MARK

TRADE

BULGIN Components are manufactured from the finest-grade materials to the highest standards and specifications.

BULGIN Components are routine and type tested, using scientifically designed test gear, to ensure adequate quality control.

BULGIN Components can be supplied in "Tropical" versions and to specifications such as RCS.1000 etc., to quantity orders.

BULGIN Components are manufactured at our completely self-contained factory at Barking, Essex.

BULGIN Technicians and designer-draughtsmen are continually working on new lines and improving existing models.

BULGIN manufacture the widest range of electronic components in the world. The range includes switches, connectors and signal-lamp fittings.

For full technical and electrical data on all the BULGIN products, send for this 144 page catalogue, price 1/-, post free. →

PLEASE NOTE: Our new telephone number is Rippleway 5588.

BULGIN **A. F. BULGIN & CO. LTD.**
BYE-PASS ROAD,
BARKING, ESSEX
 Telephone: Rippleway 3474 (5 lines)

UNBIASED

By FREE GRID

Service with a Smile

LIKE all other rabid radiotics I do my own running repairs. I was more than a little vexed therefore—in fact I was livid, as the ladies say—when I returned from a brief business trip to Paris recently and found that Mrs. Free Grid had called in the local radio dealer to attend to a fault in the TV set.

Without casting aspersions on hard-working radio dealers I always regard my set—which is, of course, of my own design—with the same possessive pride as a mother does her child and have always thought that nobody but myself could properly tend it in sickness. I was surprised, therefore, when Mrs. Free Grid told me that the set was doing its stuff better than it had ever done before. I replied angrily that obviously some simple bread-and-butter fault had developed which nobody but a fool could miss.

I will freely confess that I was quite wrong in every respect. Investigations showed me that quite a complicated fault had developed and it had been repaired in a masterly manner. When Mrs. Free Grid told me that the serviceman had been a trim and efficient-looking girl I was frankly incredulous and hurried round to the local dealer.

He gave me a cordial welcome and took great pride in presenting his service staff to me—all of them girls on the proper side of 25. He explained to me that he employed them instead of men not because of the greater nimbleness of their fingers but because their womanly intuition enabled them to diagnose the trouble and remedy the fault rapidly during the time when a mere man would still be fumbling with a



Radio trouble tracers

lot of expensive and time-consuming instruments.

He said that as a result of experience he only trained married girls with at least one child as he found that they not only had intuition but also had acquired valuable "know-how" in trouble tracing by listening to the outlandish noises made by a baby in distress. To the average man bawling babies are bedlam but to an experienced mother no two bawls are alike, one indicating the need for nourishment, another for nappies and so on.

I can only say that I came away with a new respect for radio dealers—or at any rate for this particular one. On thinking things over it occurs to me that the only way that male service technicians can dodge the dole is for them to get married, for surely fathers are equally as experienced in getting up in the middle of the night to attend to a baby with a faulty grid leak.

Living Literature

I HAVE during the past few months been making tape recordings of the B.B.C. "Book at Bedtime" feature in which an instalment of a popular novel is read late in the evening. I have sometimes criticized the books which the B.B.C. has chosen but I have always been filled with admiration for the skill with which they are read. The readers put real dramatic skill into their work and even the dulllest book seems to live; perhaps this is no more than would be expected as some of them are well known in the theatrical world.

One thing I cannot stand, however, is a *serial* story, more especially at bedtime. I am worked up to a fever of excitement wondering what the villain is going to do to the heroine when my "psyche" or "ego" receives a fearful jolt by the anti-climax of the announcer butting in with the B.B.C. equivalent of the old-fashioned *Jane's Journal's* "another gripping instalment next week."

I, therefore, arrange for the instalments to be taken down on tape, using a specially rigged-up receiver, recorder and time switch for this purpose. Eventually when the book is finished I am enabled to sit back and listen to the story in comfort.

Now I derive so much more pleasure from listening with my eyes closed to these beautifully read books than I do from reading them for myself that I venture to prophesy that in a few years publishers will beat their printing presses into tape recorders and we shall buy our books by the reel, the value of the recording being enhanced by the fame of the artist

engaged by the publisher to do the reading. There will, in fact, be as much competition among publishers to sign up famous actors for these readings as there is among recording companies to sign up famous vocalists and instrumentalists.

To a limited extent the sort of thing I envisage is already available in the well-known talking books for the blind which, originally on disc, will, I should imagine eventually be on tape.* An obvious extension of this idea which would help to put this "living literature" on the map would be to provide such a service to hospital patients. Many hospitals are now provided with multi-channel broadcasting whereby each patient can choose his radio programme by means of a switch at his bedside. Why not reserve one of these a.f. distribution channels for book reading either from a tape reproducer or the lips of a dulcet-toned nurse of the type whose voice sends your temperature up every time you hear it?

Caledonian Carefulness

FOR some odd reason the word parsimony has come to be associated with Scotland—probably due to vulgar and unfounded music-hall jokes made by comedians who have never travelled farther north than Wigan. My own experience of "Caledonia, stern and wild" is that it is a land of unbounded generosity. I have not been there since pre-war days but I recollect riding in a Glasgow tram in the 'thirties and being asked to pay only a halfpenny fare when the minimum south of the border 'vas a penny. For my humble bawbe I was carried quite a considerable distance. If this be parsimony, give me more of it!

In actual fact, of course, the Scots are not parsimonious but are "careful" and believe in getting—and giving—full value for money. This is only another way of saying they avoid waste and wantonness and I came across a remarkable example of this recently when browsing through the carbolicky pages of the *Nursing Mirror*.

It appears that in a hospital in Paisley there has been installed a "pillowphone" system for distributing radio programmes. Hundreds of Sassenach hospitals must have done the same thing and then rested on their laurels; not so the canny Scots. Desiring to install also a system whereby a patient could summon a nurse they remembered the high price of copper and did not wantonly and extravagantly install a duplicate system of wiring but made the pillowphone system serve two purposes and operate in both directions; unfortunately the *Nursing Mirror* fails to give technical data of the *modus operandi*.

*A description of a talking-book tape reproducer was given in our Jan., 1954, issue.—ED.]